

A Revision and Cladistic Analysis of the Genus *Corasoides* Butler (Araneae: Desidae) with Descriptions of Nine New Species

MARGARET HUMPHREY

Lot 6 Victor Place, Kuranda Queensland 4881, Australia

ABSTRACT. The spider genus *Corasoides* Butler, 1929 (Araneae:Desidae) is revised and nine new species described, four from Australia (*C. terania* sp. nov., *C. mouldsi* sp. nov., *C. motumae* sp. nov. and *C. occidentalis* sp. nov. and five from New Guinea (*C. angusi* sp. nov., *C. stellaris* sp. nov., *C. nimbus* sp. nov., *C. cowanae* sp. nov. and *C. nebula* sp. nov.). Keys to all species in the genus are provided. Phylogenetic relationships are constructed by means of cladistical analyses. Separate lineages of Australian and New Guinea species are revealed.

KEYWORDS. Arachnida; Araneae; Desidae; *Corasoides*; taxonomy; new species; phylogeny; spider.

HUMPHREY, MARGARET. 2017. A revision and cladistic analysis of the genus *Corasoides* Butler (Araneae: Desidae) with descriptions of nine new species. *Records of the Australian Museum* 69(1): 15–64.
<https://doi.org/10.3853/j.2201-4349.69.2017.1671>

Introduction

The genus *Corasoides* and its then only species, *C. australis*, was first described by Butler in 1929. It is a genus comprising small to large spiders which build horizontal sheet webs. The species inhabit a wide variety of habitats and are common over much of Australia and Papua New Guinea. The presence of more than one species of *Corasoides* has been suspected for some time in southern Western Australia (R. Raven, pers. comm.) and in New Guinea (Main, 1982). No specimens are known from West Papua but because suitable habitat extends across New Guinea it is anticipated that the genus occurs there. Analyses of data from allozyme electrophoresis showed that *C. australis* is a highly variable species distributed across much of the southern half of Australia and confirmed there are nine additional species found in Australia (some sympatric with *C. australis*) and in Papua New Guinea (Humphrey, 2015). This present paper formally describes those new species and redescribes *C. australis*. Phylogenetic analysis using morphology clarifies relationships of the ten *Corasoides* species and shows that the Australian and Papua New Guinean species are separate lineages.

margaret.humphrey@yahoo.com.au

Methods

Specimen data from the following museums were compiled up to 2006: *AM*, Australian Museum, Sydney; *BPBM*, Bernice P. Bishop Museum, Honolulu; *MV*, Museum Victoria, Melbourne; *QM*, Queensland Museum, Brisbane; *QVM*, Queen Victoria Museum and Art Gallery, Launceston; *SAM*, South Australian Museum, Adelaide; *TMAG*, Tasmanian Museum and Art Gallery, Hobart; and *WAM*, Western Australian Museum, Perth.

Type selection. A male was chosen where possible as the holotype and preference was given to a larger specimen that displayed more complete secondary sexual development and would be less likely to show aberrations due to adverse environmental conditions.

Measurements. All measurements are in millimetres. Measurements follow Forster & Wilton (1968) unless stated otherwise. Taxonomic measurements are of the holotype and of a paratype of the opposite sex if available. The range is given in parentheses for measurements of the carapace, abdomen and chelicerae. Other measurements can be

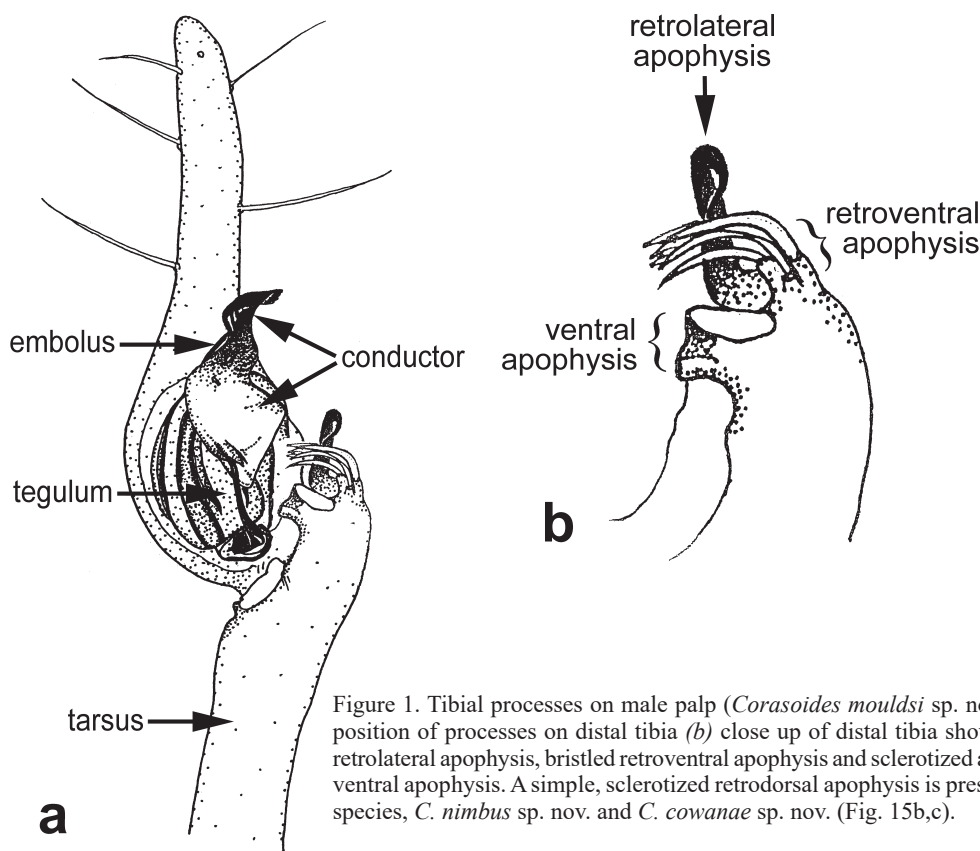

Figure 1. Tibial processes on male palp (*Corasoides mouldsi* sp. nov.) (a) showing position of processes on distal tibia (b) close up of distal tibia showing sclerotized retrolateral apophysis, bristled retroventral apophysis and sclerotized and membranous ventral apophysis. A simple, sclerotized retrodorsal apophysis is present on two PNG species, *C. nimbus* sp. nov. and *C. cowanae* sp. nov. (Fig. 15b,c).

expected to be proportional to these. All measurements are of the left side where possible. The lengths of leg segments are measured from joint to joint along the dorsal plane, and tarsus lengths do not include the claws. The median ocular quadrant has been measured without including the eyes. The height of the clypeus has been measured from the anterior margin of the carapace to the lower margin of the anterior median eyes.

Drawings. The morphological drawings have been made with the assistance of a light microscope and camera lucida. Where possible the drawings are of the holotype. The internal genitalia of the female are drawn from dissected epigynes and associated genitalia after clearing by immersion in lactic acid. Figures of internal female genitalia are drawn viewed dorsally, i.e. internally, but some additional figures are also drawn from the ventral, i.e. external, aspect. Lateral views are given of the left side as is seen from the central plane of the genitalia. Some exploded drawings are included where the convolutions of the insemination ducts are not otherwise clear. These exploded drawings are not necessarily to scale but are an interpretation of direction and relative positions. Male palps have been illustrated in the unexpanded mode.

Spination. Recording of spinal notation was made difficult by the staggered nature of the spines' position and the subsequent lack of obvious pattern. Spines were recorded, therefore, in groups where possible, ignoring areas of absence. Similarly, spines were designated mostly as either dorsal or ventral. Spines were consigned a prolateral or retrolateral designation only if they were unmistakably on a lateral midline.

Terminology

Terminology not discussed below follows that of Forster (1967) and Comstock (1912).

The following abbreviations are used when describing morphology: *AME*, anterior median eyes; *Chell*, chelicera length; *ChelW*, chelicera width; *CL*, carapace length; *CW*, carapace width; *EpGW*, epigastrium width; *HW*, head width; *Juv*, juvenile; *LL*, labium length; *LW*, labium width; *ML*, maxilla length; *MOQAW*, median ocular quadrant anterior width; *MOQL*, median ocular quadrant length; *MOQPW*, median ocular quadrant posterior width; *MW*, maxilla width; *pen*, penultimate; *SL*, sternum length; *SW*, sternum width.

Male tibial apophyses (Fig. 1). A retrolateral apophysis and a ventral apophysis are present on the distal tibia of the male palp of *Corasoides*. The retrolateral apophysis is strongly sclerotized and at least partially spine-like and tapering. The ventral apophysis is lobe-like in most species but may be erect in some species. It may be completely sclerotized or partly membranous. A retroventral tibial apophysis, bearing a terminal brush of bristles is also present in most species of Australian *Corasoides* but absent in all Papua New Guinea species. Two species from PNG have a simple, sclerotized retrodorsal apophysis.

Epigynal plugging. Plugging of the female epigyne was deemed to occur for a species if found in any specimen. Plugging was deemed not to occur if no plugging was observed in all of at least five adult females that were collected in the vicinity of adult males.

Cheliceral grooves. Cheliceral grooves are a transverse wrinkling or folding of the cuticle between the two rows of the cheliceral teeth.

Superfamily Amaurobioidea

Family Desidae

Genus *Corasoides* Butler, 1929

Corasoides Butler, 1929: 42; Neave, 1939: 833; Roewer, 1954: 61; Bonnet, 1956: 1925; Lehtinen, 1967: 225; Forster & Wilton, 1973: 128; Gray, 1981: 797; Main, 1982: 92; Brignoli, 1983: 467, 533; Davies, 1988: 70; Platnick, 1993: 541; Platnick, 1997: 609; Wheeler *et al.*, 2016: 12, 27, 34, 35.

Type species. *Corasoides australis* Butler, 1929, by monotypy.

The first inference to a spider of this genus appears to be Rainbow's (1897) description of a web identified by him as belonging to *Agelena labyrinthica*, Clerck, 1757 (a European species). From his description, and from the locality given (Sydney, Guildford and Fairfield), it seems that he was referring to what we now call *C. australis*.

Rainbow's account was noted by Butler (1929) who questioned Rainbow's identification and the presence in New South Wales of *A. labyrinthica*. Butler proceeded to describe the monotypic genus *Corasoides* and its undescribed type species, *Corasoides australis*. The only review of *Corasoides* since that time has been that of Lehtinen (1967) in which he included a New Zealand species, *Rubrius mandibularis* Bryant, 1935 (later transferred to *Mamoea*).

Family affiliations

Butler placed *Corasoides* in Agelenidae: Ageleninae, probably in part because of its platform web structure and its strong superficial resemblance to *Agelena labyrinthica*.

Corasoides remained in Agelenidae (Roewer, 1954; Bonnet, 1956) until Lehtinen (1967) transferred it to the Amaurobioidea: Desinae. Lehtinen removed *Corasoides* from Agelenidae on account of the unpaired colulus, which is unpaired in all Amaurobioidea, *sensu* Lehtinen (with one unusual exception) but paired in Agelenidae. The main attribute of Lehtinen's Amaurobioidea was the presence of a median apophysis in the male palp. Lehtinen acknowledged the absence of the median apophysis in *Corasoides* (and similarly so in *Stiphidion* and *Porteria* which he also placed in Desinae) but he regarded this as a secondary loss. Lehtinen saw a division of his Amaurobioidea into two depending upon the presence or absence of a secondary conductor. Classical characters based on spination, trichobothria, maxillae, eyes etc., he regarded as inconsequential and often associated with overall size (Lehtinen, 1978). Those subfamilies lacking a secondary conductor included Desinae, Matachiinae and Stiphidiinae.

Forster & Wilton (1973) raised the subfamily Stiphidiinae Dalmat, 1917 to family status within the Amaurobioidea. They placed the New Zealand *Cambridgea*, *Nanocambridgea* and *Ischalea* in Stiphidiidae as well as the Australian *Baiami*, *Procambidgea* and *Corasoides*. Morphologically, Forster & Wilton (1973) restricted the Amaurobioidea to those taxa with a well-developed and strongly sclerotized median apophysis while Stiphidiidae they defined as possessing a simple median apophysis that showed a strong tendency to reduction and eventual loss as in *Corasoides*.

Stiphidiidae remained in the Amaurobioidea on account of the presence of the median apophysis (or its assumed

secondary loss) and the weakly developed and unbranched tracheal system that is confined mainly to the abdomen (Forster & Wilton, 1973).

The position of *Corasoides* in Lehtinen's Amaurobioidea, Desinae, is dependent upon the absence, as a secondary loss, of both the median apophysis and the secondary conductor in *Corasoides*. Members of Lehtinen's Desinae show a trend towards reduction or loss of the median apophysis.

Griswold *et al.* (1999) showed that Amaurobioidea (*sensu* Lehtinen, 1967) is polyphyletic and several of his subfamilies, including Desinae, did not belong in the Amaurobioidea. This confirmed aspects of Forster & Wilton's (1973) treatment of Lehtinen's Amaurobioidea, including the raising of the Desinae to family status within the Dictynoidea. While they transferred many of the genera that Lehtinen had placed in the Amaurobioidea to their new family Desidae, based upon the branching structure of the tracheae, they excluded *Corasoides*. *Corasoides* cannot be placed in Forster & Wilton's Desidae because of the absence of a well-developed and sclerotized median apophysis and its simple, unbranched tracheal system.

Forster & Wilton's (1973) elevation of the Stiphidiinae to family status and the inclusion of *Corasoides* remained problematic. The colulus of Stiphidiidae is typically a large, hairy, flattened plate, suggesting recent reduction from a cribellum; the colulus of *Corasoides* (and *Cambridgea*) has the form of a small, semicircular flap.

The Stiphidiidae are not adequately separated from the Agelenidae, especially since Forster & Wilton have included within the Agelenidae taxa with a single, undivided colulus and with unelongated posterior spinnerets. The only attribute setting Agelenidae (*sensu* Forster & Wilton, 1973) apart from other families is the absence of trichobothria on the cymbium. This attribute excludes *Corasoides* from Agelenidae.

Forster & Wilton (1973) admitted that the structure of the web was the most distinctive feature of the Stiphidiidae. They explained how it could easily have been transformed from the flat, cone-shaped web of *Stiphidium* (*sic*, misspelling of *Stiphidion*) into the platforms of *Cambridgea*, *Nanocambridgea*, *Procambidgea* and other genera they placed in Stiphidiidae. However, this explanation is dependent upon the spider moving on the under surface of the web and Forster & Wilton mistakenly attributed this behaviour to *Corasoides*, which moves on the upper surface of the web. There is also a presumption that this is how *Stiphidion* use their web platform.

The importance of the tracheal system as a taxonomic indicator is also doubtful since it is not consistent even within the classification of Forster & Wilton. In addition, Lehtinen (1978) pointed out that Lamy's (1902) work showed that the degree of tracheal branching could be dependent upon environmental adaptation, that is, tracheal ramification was often indicative of an active hunting life style.

This leaves no remaining argument from Forster & Wilton (1973) for including *Corasoides* in their Stiphidiidae. Gray (1981) also questioned the placement of *Corasoides* within Forster & Wilton's Stiphidiidae.

Davies (1988) in her discussion of the family placement and relationships of *Stiphidion*, suggested removal of *Ischalea* (on account of the presence of lateral teeth on the epigyne and a well-developed median apophysis) and *Procambidgea* (on account of its marked trochanteral

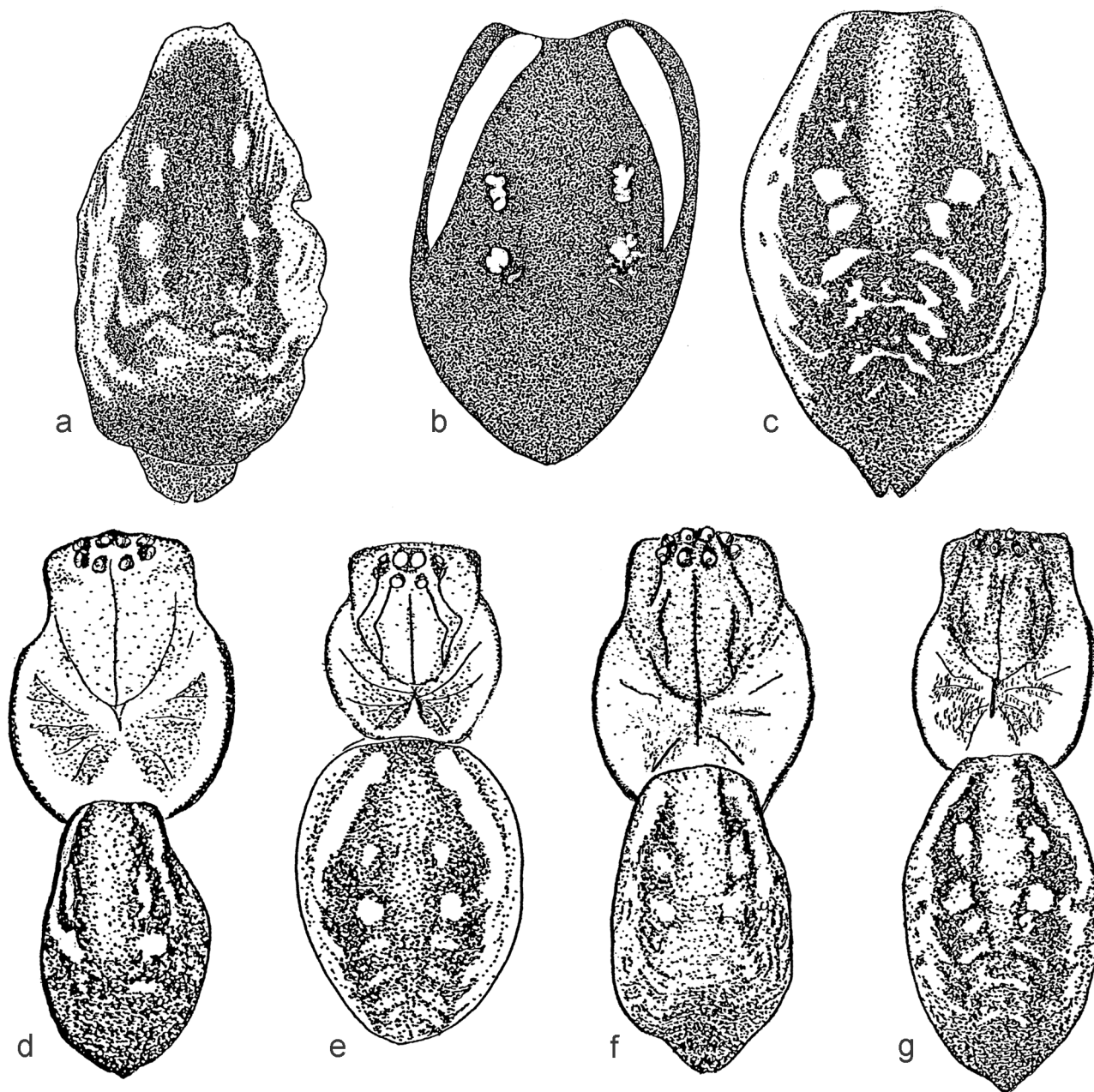

Figure 2. *Corasoides australis*, dorsal abdomen or abdomen and carapace; (a) male, presumed syntype, Cheltenham, Vic.; (b) female, Waddy Point, Vic.; (c) female, Sydney, NSW; (d) male, Edland, WA; (e) female, Kalgoorlie, WA; (f) male, Eddystone Point, Tas; (g) female, Hobart, Tas.

notches, proximal calamistrum and unusually reduced AME) from Stiphidiidae. She, however, retained *Corasoides* within the Stiphidiidae, along with *Baiami*, *Cambridgea* and *Nanocambridgea* and *Stiphidion*, as these share a reduced or absent median apophysis, an epigyne without lateral teeth, an extensive conductor and a spiniform embolus.

Wheeler *et al.* (2016), using results from phylogenetic analyses of markers from mitochondrial and nuclear genomes, transferred *Corasoides* from Stiphidiidae to Desidae. Similarly, the Australian *Baiama* and the closely related *Cambridgea* and *Nanocambridgea* from New Zealand (all of which run on the under surface of their web) were also transferred from Stiphidiidae.

Porteria, retained in Desidae, is well supported as the sister group to *Corasodes*. Lehtinen (1967) first made the

Australian/South American connection, linking *Corasoides* and *Porteria* in his Desinae on the basis of their similar abdominal pattern (although a similar pattern can also be found in some *Dolomedes*), the absence of a median apophysis and the pattern of pyriform spigots on the anterior lateral spinnerets. Both *Corasoides* and *Porteria* also run on the upper surface of their web.

Wheeler's support for Porterinae, which contains the above mentioned five genera, was strong, although support for Desidae itself was weak. His Desidae is diverse, including genera both cribellate and ecribellate, with simple to complex tracheae and the spider's running atop or below the web. Wheeler was inclined to raise the Porterinae (and several other groupings) to family level but declined to do, so awaiting further study and the inclusion of more genera.

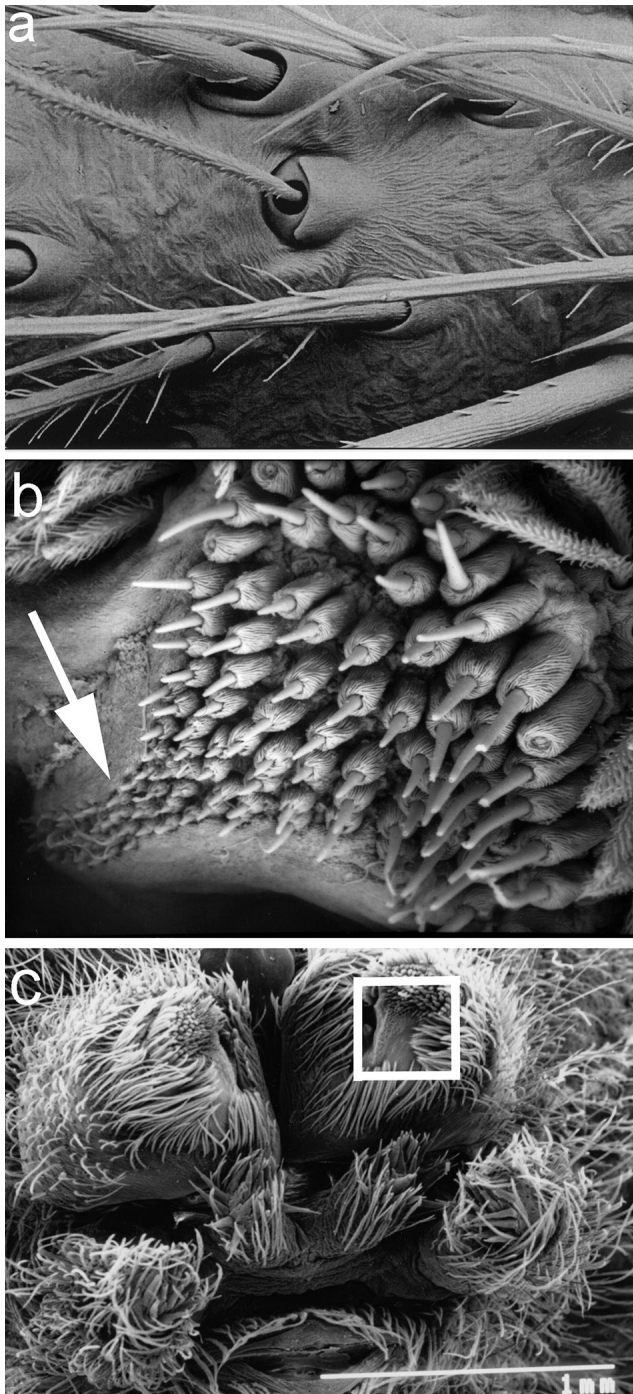

Figure 3. (a) Trichobothrium and hairs from tarsus of *Corasoides australis*, Sydney, NSW; (b) tail of spigots on prolateral surface of anterior spinneret *C. australis*, Pearl Beach, NSW; (c) spinnerets from *C. australis*, Broadwater, NSW, showing area of spigot tail.

Diagnosis

Within Wheeler's Porterinae, *Corasoides* can be distinguished behaviourally from *Nanocambridgea*, *Cambridgea* and *Baiami* by its web structure and mode of moving on the upper surface of the platform. Morphologically *Corasoides* can be separated from these genera by the distinct abdominal pattern (Figs 2a–g, 5a–c, 15d, 30a, 33a): pseudo-feathery hairs (Fig. 3b, upper right); more retromarginal than promarginal cheliceral teeth; male palp with acutely bent and spine-like retrolateral tibial apophysis and a bristled retroventral apophysis.

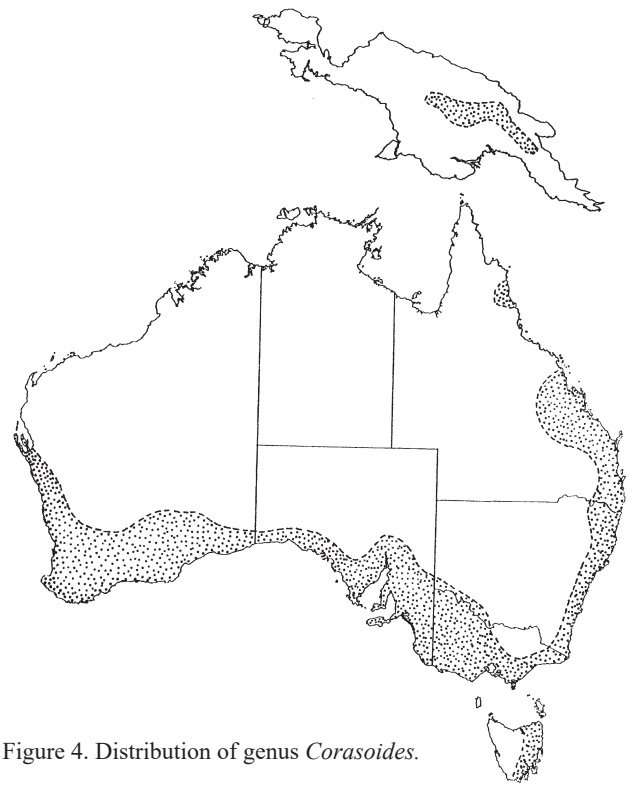

Figure 4. Distribution of genus *Corasoides*.

Simon's description of *Porteria* is inadequate and this genus is currently under study (Merrill, 2014; unpublished thesis). Wheeler has described *Corasoides* as appearing as a giant version of *Porteria*. Until further details are available, *Corasoides* can be distinguished from *Porteria* by the presence in most species of three (sometimes two), rather than four tibial processes and the absence of notches on the trochanter.

Description

Small to large (carapace length 2.1–7.9 mm), ecribellate spiders.

Carapace. Longer than wide with discernible head area. Fovea long. Carapace cream to reddish tan to black, darker in head and cheliceral area. Carapace with little pattern or with a pattern consisting of a cream to light tan background with a medial, light brown or tan stripe from ocular quadrangle to pedicel. This is flanked on either side by a brown or tan region extending to the posterior of the carapace but excluding the petiole region and the carapace is bounded by dark edging. Maxillae long, distally enlarged and converging. Labium basally notched. Sternum as long or longer than wide, with distinct posterior point produced between coxae IV. Clypeus broad, often concave in male.

Abdomen. Ovate. Basic pattern, dorsum: central pale stripe or medial area, white/yellow dorsolateral stripes at least to anterior third of abdomen, two rows of white/yellow spots on black background between dorsolateral stripes and central stripe and decreasing in size posteriorly and with first two pairs prominent. In some specimens, the pattern may be less distinct and in some species may be reduced to a vague double row of pale spots on the dorsal surface (Figs 2, 5, 15d, 30a, 33a). Venter pale, laterally with black striation.

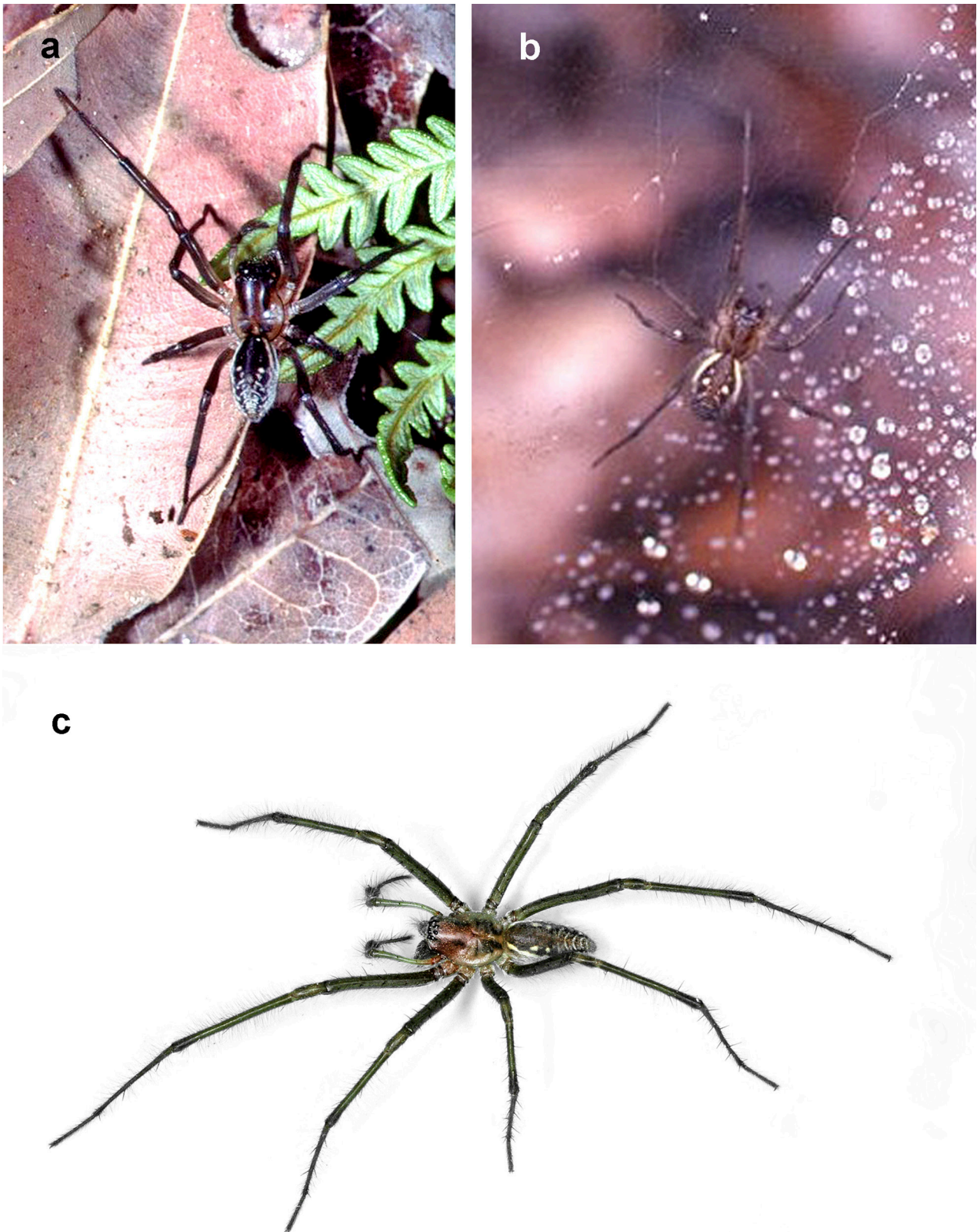

Figure 5. *Corasoides australis*: (a) Mt. Wilson, NSW; (b) Collie, WA; (c) *Corasoides occidentalis* sp. nov. Ioppolo Nature Reserve, WA.

Eyes. Anterior row eyes slightly procurved, posterior row more strongly procurved. AME largest and circular, other eyes slightly smaller and elliptical. All eyes hyaline, surrounded by dark pigment (Fig. 6f). Tapetum in lateral eyes canoe-shaped.

Chelicerae. Robust and long, extending ventrally well below the level of the sternum. Distinct boss present in most species. Two pairs of prominent frontal bristles present and usually crossing each other in front of chelicerae (Fig. 6d, 13d). Cheliceral retromargin with more teeth (5–8) than

promargin (2–4). Cheliceral teeth may be variable within species (Fig. 8a–j) and even from left to right in specimens (Fig. 8f). Cheliceral groove with or without transverse ridges. Fangs with or without serrations.

Legs. Formula 1,4,2,3. Superior claws similar, strongly pectinate, inferior claw with 2–3 teeth. Single row of 4–8 trichobothria on tarsus, decreasing in length proximally. Tarsal organ simple, pyriform, sited apically beyond last trichobothrium. 4th metatarsus longest leg segment. First tibia often longer than 1st metatarsus. Trochanters unnotched.

Hairs. Hair types present include plumose, ciliate and “pseudofeathery”. Pseudofeathery hairs (Fig. 3b, upper right) differ from feathery hairs in having shorter tines which project from more than one plane.

Male palp. Cymbium with long digitiform portion at least twice and up to six times as long as the diameter of the palpal bulb. Single row of 2–7 trichobothria present (Fig. 3a) decreasing in length proximally. Median apophysis absent. Conductor stalked or T-shaped. Conductor tip sclerotized, spine-like, twisted or bent. Both sides of the conductor may equally form the conductor tip or the ventral side may be dominant. Secondary conductor absent. Embolus long, curved and filiform, arising prolaterally to retrolaterally. Tibia with 2–3 apophyses. Retrolateral tibial apophysis spine-like, tapering, bent or curved. Ventral apophysis, when present, lobe, cup or leaf-like. Retroventral apophysis, when present, finger-like with long, terminal brush of curved bristles. Retrodorsal apophysis, when present, simple and sclerotized.

Epigyne. Strongly sclerotized, paired copulatory openings separated by scape with or without lateral extension.

Spermathecae large. Insemination ducts weakly or strongly convoluted. Diverticula often present at junction with spermathecae. Epigynal atria may or may not be plugged. Appearance of external epigyne variable even within species (Fig. 11a–l).

Spinnerets. Distinct overflow or tail region of small spigots prolaterally on anterior lateral spinnerets in most species (Fig. 3b). Colulus single, flat, semi-circular, clothed in hairs.

Tracheal system. Four unbranched tubes, confined to the abdomen.

Web. Platform sheet web with labyrinth above and retreat to side through silken funnel, with or without a burrow (Fig. 7h). Spider runs on top of sheet. Silk is cribellate and non-sticky. Egg sacs with thick layer of soil or debris hung by thread of silk from roof of burrow. Males may or may not cohabit with penultimate females.

Distribution

The coastal strip of eastern and southern Australia and up to 350 km inland, from the Carbine Plateau in north eastern Queensland to Tasmania and west to Shark Bay, Western Australia, and the central mountain range of Papua New Guinea at altitudes from 1800–3000 m (Fig. 4).

Habitat

In Australia *Corasoides* occurs in semi-arid areas, open woodland, heathland, dry and wet sclerophyll forest and tropical and temperate rainforest. In Papua New Guinea *Corasoides* inhabits high altitude mist forest.

Key to males

Corasoides stellaris sp. nov., not included, males are unknown.

- | | | |
|---|--|---------------------------------|
| 1 | Bristled retroventral apophysis present (Australia only) | 2 |
| — | Bristled retroventral apophysis absent | 5 |
| 2 | Smooth semicircular flange around tip of conductor (Figs 26a–c, 26e,f, 28a–d) | <i>C. occidentalis</i> sp. nov. |
| — | Conductor tip without flange | 3 |
| 3 | Ventral apophysis fully sclerotized | <i>C. motumae</i> sp. nov. |
| — | Ventral apophysis with unsclerotized retrolateral portion | 4 |
| 4 | Origin of embolus basal; conductor tip ridged | <i>C. mouldsi</i> sp. nov. |
| — | Origin of embolus retrolateral; conductor tip smooth | <i>C. australis</i> Butler |
| 5 | Distal cheliceral tooth greatly enlarged; carapace shorter than 3.0 mm (Papua New Guinea only) | 6 |
| — | Distal cheliceral tooth no larger than others; carapace longer than 4.0 mm | 7 |
| 6 | Retrodorsal tibial apophysis present | <i>C. cowanae</i> sp. nov. |
| — | Retrodorsal tibial apophysis absent | <i>C. nebula</i> sp. nov. |
| 7 | Spine-like portion of retrolateral apophysis arising from retro-lateral extremity of its base | <i>C. terania</i> sp. nov. |
| — | Spine-like portion arising centrally from base | 8 |
| 8 | Origin of embolus prolateral; retrolateral apophysis bent 180° | <i>C. angusi</i> sp. nov. |
| — | Origin of embolus distal to retrolateral; retrolateral apophysis bent 90° | <i>C. nimbus</i> sp. nov. |

Key to females

Australia

- 1 Atria of genital openings large, extending almost to lateral edges of epigyne 2
 — Atria not as above 3
- 2 Epigyne length: width greater than or equal to 1:2 *C. terania* sp. nov.
 — Epigyne length: width less than 1:2 *C. motumae* sp. nov.
- 3 Scape extends laterally to outer edge of genital openings *C. occidentalis* sp. nov.
 — Scape not as above 4
- 4 Genital openings smooth, circular, diameter at least width of scape; insemination ducts with 2 bends located between spermathecae *C. mouldsi* sp. nov.
 — Genital openings small, irregular, diameter usually less than width of scape; insemination ducts highly convoluted, with more than 5 bends surrounding spermathecae *C. australis* Butler

Papua New Guinea

- 1 Carapace length greater than 3.0 mm; tail of spigots present on outer face of anterior lateral spinnerets 2
 — Carapace length less than 3.0 mm; tail of spigots not present 4
- 2 Large diverticulum present at junction with spermatheca; width of lateral extension of scape roughly equal to width of epigyne *C. stellaris* sp. nov.
 — Diverticulum absent or less than one-tenth diameter of spermatheca; width of lateral extension of scape roughly half the width of the epigyne 3
- 3 Insemination ducts slightly convoluted (3 bends) *C. angusi* sp. nov.
 — Insemination ducts highly convoluted (8 bends) *C. nimbus* sp. nov.
- 4 Genital openings at right angles to venter *C. cowanae* sp. nov.
 — Genital openings directed anteriorly and parallel to venter *C. nebula* sp. nov.

Corasoides australis Butler, 1929

Figs 2, 3, 5–12

Agelina [sic] *labyrinthica* Rainbow, 1897: 528, misidentification, noted by Butler (1929).

Corasoides australis Butler, 1929: 42; Butler, 1939: 186; Roewer, 1954: 61; Bonnet, 1956: 1203; Platnick, 1997: 609.

Types. Presumed syntype male, in MV, labelled “*Corasoides australis* Butler type male K-108”, and on another pencil-written label, “*CORASOIDES australis* GENOTYPE, G.S.G. BUTLER, Roy. Soc. Vic. 1929”. The male shares a vial with a female which is distinguished as “type female K-109”. There is no collection locality or date label and the only labels present would appear not to be original—the whereabouts of original labels is unknown.

Type locality. Two localities and dates are given by Butler (1929) for material examined, Cheltenham, 12 April 1925 and Waddy Point, Victoria, 10 January 1929. In the same

paper he recorded the type locality as Cheltenham but no state was given. It is probable that since he lived near Cheltenham in Victoria, that this is the type locality intended and not Cheltenham in Queensland or New South Wales. Further, in the register of the MV records, the locality of the male is given as Cheltenham, Victoria.

Type status. Butler (1929) described both sexes, stating the type locality as “Cheltenham”. He specifically mentions that he had only one female that was collected in January near Bairnsdale, Victoria. Since Butler did not include Bairnsdale as a type locality, this female cannot strictly be considered a syntype.

He did not indicate how many males were collected from Cheltenham, nor whether he also collected males from Waddy Point. Subsequently, it cannot be assumed that the existing male is the only specimen from the type locality (Recommendation 73F, ICZN, 1999). Therefore this specimen should be regarded as a syntype.

Material examined. Male and female as above and the following:

Queensland. 1♀, 1♂, Fraser Island, 25°39'S 153°05'E, July 1995, M. Humphrey & M. Moulds, KS.71796; 1♂, 1 juv, Narayan, 25°43'S 150°50'E, July 1995, M. Humphrey & M. Moulds, KS.71817; 1♀, Blackdown Tableland, 23°50'S 149°03'E, M. Humphrey & M. Moulds, KS.71818; 1♂, 1♀, Blackdown Tableland, 23°50'S 149°03'E, M. Humphrey & M. Moulds, KS.71803 (AM). 1♀, Braemar SF, SE QLD, cypress & brigalow, 27°13'S 150°50'E, 15–19 Oct. 1979, R. Raven & QM, QM S14666; 2♀♀, Freshwater Lake, Coolooloa, SE QLD, rainforest, 26°00'S 153°08'E, V. Davies, R. Raven, QM S14667; 1♀, Moreton I, SE QLD, 27°19'S 153°24'E, 25 Nov. 1976, V. Davies N. Hall, QM S14669; 1♀, Endfield Stn, 40 mi W Westmar, SE QLD, Mulga, 27°55'S 149°43'E, R. Raven, V. Davies, QM S14675; 2♀♀, Altonvale Stn, 40 mi W Westmar, SE QLD, 28°01'S 149°15'E, V. Davies, R. Raven, QM S14676; 5 juv, Double I Pt, Little Freshwater Ck, SE QLD, 25°58'S 153°10'E, 14–15 Jul 1985, J. Gallon, QM S14684; 1♀, Teewah Ck, Coolooloa, SE QLD, heathland, 26°05'S 153°02'E, 14 Jul. 1973, R. J. Raven, QM S14685; 1♂, Carnarvon NP, Mt Moffat Sect., 25°03'S 147°53'E, malaise 27.xi.1997, C. Lambkin, J. Shevington, S Evans, S42582 (QM).

New South Wales. 1♀, Ballimore nr Dubbo, 32°12'S 148°54'E, 29 Jan 1953, V. Levitt, KS.3563; 1♀, Garie Beach, 34°10'S 151°05'E, 12 March 1966, R. Mascord, KS.4671; 1♀, Pearl Beach, 33°33'S 151°18'E, Dec. 1977, M.R. Gray, KS.18828; 1♂, 1♀, 1 juv, Lindfield, 33°47'S 151°10'E, 1959, M. Gregg, KS.4574; 1♂, 1♀, Sydney region, 33°53'S 151°13'E, 7 Oct 1965, R. Mascord, KS.3564; 1♂, Hornsby Heights, 33°40'S 151°06'E, Oct. 1992, M. Tio, KS.71801; 1♀, Malabar, 33°58'S 151°15'E, 21 Sept. 1977, R. Mascord, KS.3563; 1♀, 1 juv, Gibraltar Ra NP creek behind ranger office, 29°35'S 152°13'E, 11 Feb 1982, C. Horseman, KS.9220; 1♀, West Head, Kuring-gai Chase NP, nr creek in burnt area, 33°42'S 151°14'E, Jan 1978, M. Gray & D. Hain, KS.1280; 1♂, Booderee NP, southern headland of Jervis Bay, 35°08'S 150°45'E, 10 Dec. 1998, L. Gibson, KS.62937; 1♂, Myall Lakes NP, 32°29'S 152°23'E, 26 Nov. 1997, L. Wilkie, KS.60767; 1♂, Munmorah State Recreation Park, 33°12'S 151°34'E, 16 Dec 1996, L. Wilkie, KS.62430; 1♂, Wyrabalong NP, 33°16'S 151°32'E, 27 Nov. 1997, L. Wilkie, KS.62431; 1♂, Wyrabalong NP, 33°16'S 151°32'E, 16 Nov. 1996, L. Wilkie, KS.62432; 1♂, Myall Lakes NP, 32°29'S 151°21'E, 26 Nov 1997, L. Wilkie, KS.62433; 1♂, Wyrabalong NP, 33°16'S 151°32'E, 27 Nov 1997, L. Wilkie, KS.62434; 1♂, Wyrabalong, 33°16'S 151°32'E, 27 Nov 1997, L. Wilkie, KS.62435; 1♂, Malabar, 33°58'S 151°15'E, 01 Jan 1965, R. Mascord, KS.4670; 1♂, Lower Murray-Darling region, Ki Downs Station, 34°38'S 142°34'E, 05 Dec 1998, M. LeBreton, KS.66985; 1♀, 1 juv, Vincentia, 35°04'S 150°40'E, 26 Dec 1990, M. Tio, KS.71805; 1♂, Gilgandra, 31°43'S 148°39'E, Jan 1993, M. Tio, KS.71807; 1♀, Hornsby Heights, 33°40'S 151°06'E, 1991, M. Tio, KS.71809; 1♂, Ballimore, 32°12'S 148°54'E, Oct 1992, M. Tio, KS.71794; 1♂, Ballimore, 32°12'S 148°54'E, 03 Oct 1992, M. Tio, KS.71810; 1♂, Mt Kuringai, 33°39'S 151°08'E, Oct 1994, M. Humphrey, KS.71808; 1♀, Hornsby Heights, 33°40'S 151°06'E, Jan 1993, M. Tio, KS.71806; 1♀, Mini Ha Ha Falls, 33°40'S 150°21'E, Nov 1994, M. Humphrey, KS.71804; 1♂, Hornsby Heights, 33°40'S 151°06'E, 17 July 1991, M. Humphrey, KS.71831 (AM). 1♀, 1 juv, Fitzroy Falls, 10 May 1979, D. Hirst, ARA5322 DH156 (SAM).

Victoria. 1♀, 1 juv, Highett, 37°57'S 145°03'E, 12 April 1953, W. Hickman, KS.28397; 1 juv, Grampian Ra, Lower Silverband Rd, 24 March 1974, M. Gray. KS. 3567; 1♂, 1♀, Wilsons Promontory, 39°04'S 146°20'E, 1992, M. Humphrey & T. Goh, KS.71819; 1♂, Lakes NP, 38°00'S 147°40'E, 18 Jan 1992, M. Humphrey, KS.71823; 1♂, Lakes NP, 38°00'S 147°40'E, 18 Jan 1992, M. Humphrey, KS.71802 (AM). 2♂♂, 17.5 km SW of Hattah, 34°50'S 142°07'E, Site 34, drift fence pitfall trap, October 1985, A. L. Yen; 1♂, 17.0 km SW of Hattah, 34°50'S 142°07'E, Site 35, drift fence pitfall trap, October 1985, A. L. Yen; 1♂, 15.0 km SSE of Hattah, 34°54'S 142°15'E, Site 29, drift fence pitfall trap, no date, A. L. Yen; 1♂, 9.0 km ESE of Hattah, 34°48'S 142°22'E, Site 3, drift fence pitfall trap, May 1986, A. L. Yen; 1♂, 3.0 km NE of Hattah, 34°45'S 142°17'E, Site 23, drift fence pitfall trap, October 1985, A. L. Yen; 1♂, 20.8 km SE of Hattah, 34°52'S 142°28'E, Site 7, drift fence pitfall trap, no date, A. L. Yen; 2♂♂, 6.3 km N of Hattah, 34°43'S 142°17'E, Site 25, drift fence pitfall trap, no date, A. L. Yen; 1♂, 19.0 km SE of Murrayville, 35°24'S 141°19'E, Site 75, drift fence pitfall trap, Nov 1985, A. L. Yen; 1♂, 16.5 km SSW of Murrayville, 35°25'S 141°09'E, Site 66, drift fence pitfall trap, Nov 1985, A. L. Yen; 1♂, 16.2 km SE of Murrayville, 35°22'S 141°19'E, Site 72, drift fence pitfall trap, Oct 1986, A. L. Yen; 1♂, 16.8 km SSW of Murrayville, 35°25'S 141°10'E, Site 66, drift fence pitfall trap, Nov 1985, A. L. Yen; 1♂, 15.9 km SSW of Murrayville, 35°24'S 141°09'E, Site 65, drift fence pitfall trap, Nov 1985, A. L. Yen; 1♂, 20.4 km NE of Patchewollock, 35°14'S 142°19'E, Site 55, drift fence pitfall trap, Oct 1985, A. L. Yen; 1♂, 4.6 km N of Millewa Sth Bore, 34°44'S 141°04'E, Site 94, drift fence pitfall trap, Oct 1986, A. L. Yen; 1♂, 15.4 km NE of Lascelles, 35°17'S 142°19'E, Site 50, drift fence

pitfall trap, October 1985, A. L. Yen; 1♀, Little Desert, 22 Oct 1948, no collector; 1♀, Nanawading, 20.12.19[9]55, Nebois; 1♀, Laverton, 15 Dec 1963, no collector (MV). 1♂, Halls Gap, Nov 1950, D. Hirst, ARA5322 N19921 (SAM).

Tasmania. 1♀, Oppossum Bay, 42°59'S 147°24'E, 04 Jan 1938, W. Hickman, KS.28300 (AM). 1♀, Clutha Place, South Hobart, 4-xi-979, J. Barclay (TMAG). 1♂, Eddystone Point (site 4), North East Tas, 41°00'44"S 148°19'15"E, Churchill T, /11/1987, 13:3753; 1♂, Eddystone Point (site 4) North East Tas, 41°00'44"S 148°19'15"E, T. Churchill, /11/1987, 13:3804; 1♂, Eddystone Point (site 4) North East Tas, 41°00'44"S 148°19'15"E, T. Churchill, /10/1987, 13:3524 (QVM).

South Australia. 1♂, Whyalla, 33°02'S 137°35'E, 15 Oct 1993, M. Humphrey, KS.71795; 1♂, Lincoln NP, 34°47'S 135°44'E, 14 Oct 1993, M. Humphrey, KS.71811; 1♂, 76 km W Nullarbor, 31°26'S 130°05'E, 26 Sept 1993, M. Humphrey, KS.71812; 1♂, 1♀, 1 juv, Nullarbor, 31°25'S 130°53'E, 25 Sept 1993, M. Humphrey, KS.71814; 1♀, 30 km E Morgan, 34°04'S 139°40'E, 17 Oct 1993, M. Humphrey, KS.71815; 1♂, Wilpena, 31°31'S 138°37'E, 15 Oct 1993, M. Humphrey, KS.71816; 1♀, Streaky Bay, 32°35'S 134°08'E, 13 Oct 1993, M. Humphrey, KS.71822 (AM). 1♂, Nepean Bay Cons. Park, 8 km Kingscote, Kangaroo Island (pitfall), 29 Oct.–02 Nov. 1990, NPWS Survey, ARA 5322, N19922; 1♂, Sugar Gum Lookout Track, Mt Remarkable NP, 13 Oct. 1982, G. Coombs, ARA 5322, N199211; 1♂, 7 km N Ravine de Casoars, Flinders Chase, Kangaroo Island, pitfall, 2–7 Nov. 1990, E. G. Mathews, J. A. Forrest, ARA5322 199210; 2♀♀, Ravine de Casoars, Kangaroo Island, 06 Nov. 1987, D. Hirst, ARA5322 N19927–8; 1♀, Ravine des Casoars, Kangaroo Island, 2Dec [year not given], A Fuller J Reid M Bennett J Pennington, ARA5322 N19929; 1981, Nov. 1987, D. Hirst, ARA5322 N19927–8; male, 4.2 km SW Cape Willoughby Lighthouse, Cape Hart Pk, Kangaroo Island, 11–16 Nov. 1990, P. Copley, P. Canty, B. Cohen, NPWS Survey, ARA 5322 N19923; 1♀, Dudley C.P. Kangaroo Island, 11 Nov. 1987, D. Hirst, ARA5322 N19925; 1♀ + sacs, Mt Sturt, 3 km S, 32°45'S 135°24'E, 13 Dec. 1989, D. Hirst, ARA5322 N199221; 1♂, Dudley Conservation Park, Kangaroo Island (pitfall), 5–11 Nov. 1990, D. Hirst, ARA5322 N19924; 1♂, 31 km SW Pinnaroo, 35°26'45"S 140°53'06"E, 06 Nov. 1991, NPWS Murray Valley Survey, ARA5322 N199380; 1♂, 23 km S Lameroo, 35°30'50"S 140°34'30"E, 4–8 Nov 1991, NPWS Murray Valley Survey, ARA5322 N199387; 1♂, 4 km SE Quandong Bore, 35°32'20"S 140°46'12"E, 04 Nov. 1991, NPWS Murray Valley Survey, ARA5322 N199382; 1♂, 4 km Box Flat, 35°38'52"S 140°22'55"E, 11–14 Nov. 1991, NPWS Murray Valley Survey, ARA5322 N19984; 1♂, 14 km SE Baan Hill, 35°37'26"S 140°28'44"E, 10–14 Nov. 1991, NPWS Murray Valley Survey, ARA5322 N199385; 1♂, 1 km N The Needles, 35°49'44"S 139°22'40"E, 4–8 Nov. 1991, NPWS Murray Valley Survey, ARA5322 SAMA N199385; 1♂, 6 km W Kirra, 35°45'57"S 140°50'02"E, 12 Nov. 1991, NPWS Murray Valley Survey, ARA5322 N199386; 1♀ + sac, Mt Sturt, 3 km S, 32°45'S 135°24'E, 13 Dec. 1989, D. Hirst, ARA5322 N199220; 1♀, 11 km NW Magrath Flat, 35°47'16"S 139°19'33"E, 3–8 Nov. 1991, NPWS Murray Valley Survey, ARA5322 N199387; 1♀, Bridgewater, Mt Lofty Ranges, Dec. 1983, B. Guerin, ARA5322 N1992128; 1♀, Bridgewater, Mt Lofty Ranges, 35°00'S 138°45'E, 9 Feb. 1985, D. Hirst, ARA5322 DH252; 1♂, 50 km W Yalata Roadhouse, 31°29'30"S 131°16'00"E, Sept. 1984, Nullarbor Survey, ARA5322 N199229; 1♀, top of coastal cliffs, Whaler Way, 34°56'S 135°40'E, (SW Pt Lincoln), 17 Dec. 1981, D. Hirst, ARA5322 DH255; 2♀♀, Head of Bight, 28 Sept. 1988, D. Hirst, ARA5322 N199227–8; 1♂, sand dunes, Nora Criena, 37°20'S 139°51'E, March 1978, D. Hirst, ARA5322 DH251; 1♀, Alligator Gorge, 32°45'S 138°03'E, 25 Jan. 1987, ARA5322 DH257; 2♀♀, Kyeema, Mt Lofty Ranges, 35°10'S 138°40'E, Jan–Feb 1980, D. Hirst ARA 5322 N199231–2; 1♀, Slopes of Iron Duke, 17.viii.1974, G. Coombe N199219; 1♀, "Scenic Walk" American River Kangaroo Island, 11 Nov 1987, D. Hirst, ARA5322 N19926; 1♀, Bald Hill Beach nr Port Wakefield, 21 Oct 1989, D. Hirst, ARA5322 N199212; 1♀, Kolay hut, 32°33'S 135°13'E, 10 Dec 1989, D. Hirst, ARA5322 N199226; 1♂, 3 pen ♀♀, Lake Gilles Conservation Park, 32°58'S 136°45'E, 24–25 Sept 1988, D. Hirst, ARA5322 N199222–25; 1♂, Whyalla, 5 m [sic, ?mi] SE Mt Young, 18-8-1974, J. White, ARA5322 N199218; 5♂♂, Bungunnia Station, (NE Morgan) Jumby East Dam, 13 Oct 1980, J. Whitehead, ARA5322 N199213–17 (SAM). 1 juv, Ivy Tanks, 31°16'S 131°18'E, May 1968, (no collector), 92/63 (WAM).

Western Australia. 1♂, 30 km W Eucla, 31°41'S 128°33'E, 19 Oct 1993, M. Humphrey, KS.71813; 1♂, 30 km W Eucla, 31°46'S 128°33'E, 12 Oct 1993, M. Humphrey, KS.71821; 1♀, Zanthos, 31°02'S 123°34'E, Nov 1991, H. Rose, KS.71824; 1♂, 2 km W of Coolgardie, 30°57'S 121°09'E, 11 Oct 1993, M. Humphrey, KS.71825; 1♀, 1 juv, Coolgardie, 30°57'S 121°09'E, Oct 1993, M. Humphrey, KS.71826; 1♂, Greenough, 28°57'S

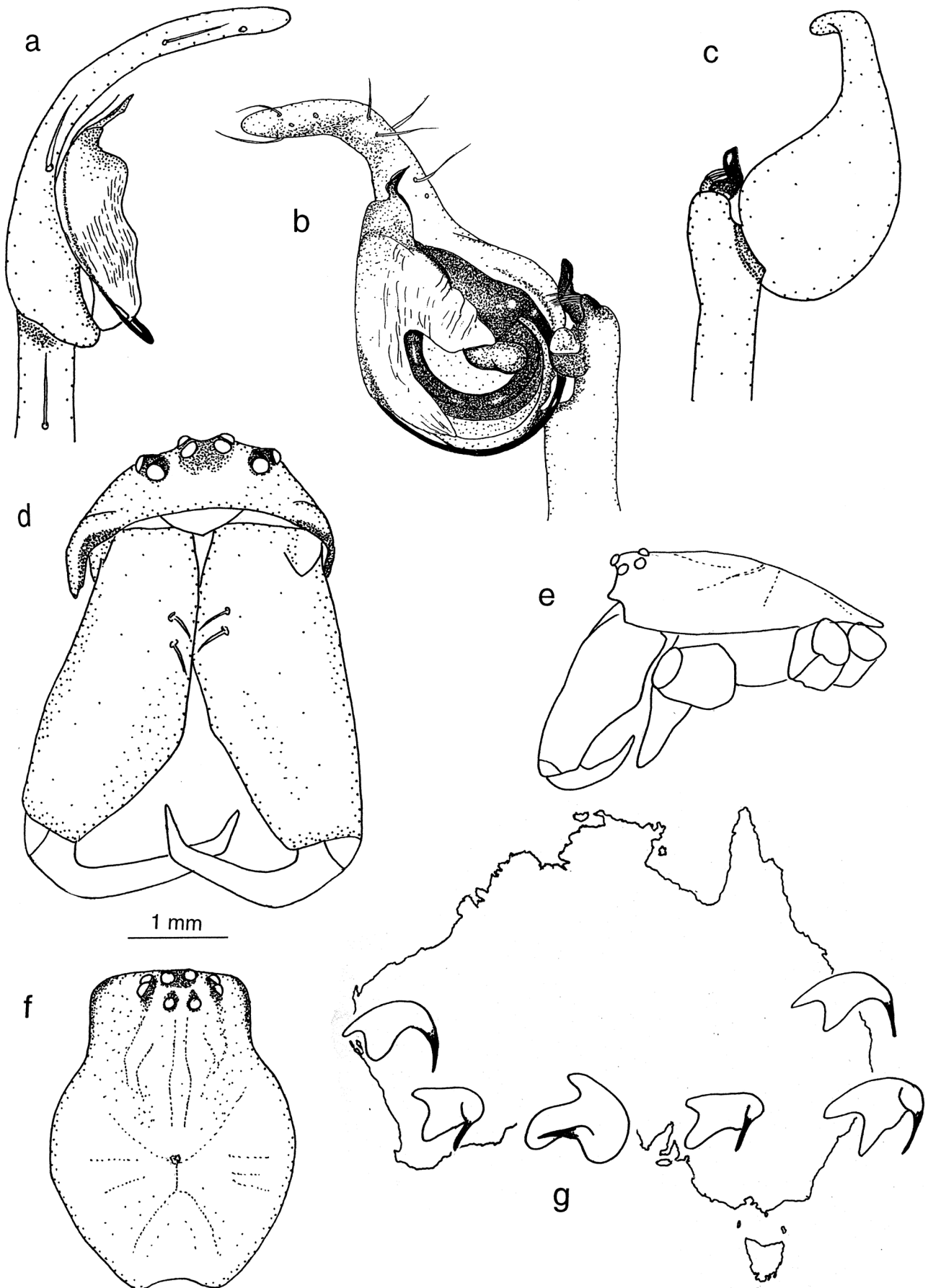

Figure 6. *Corasoides australis* male (a) palpal organs, prolateral; (b) palpal organs, ventral; (c) palpal organs, retrolateral; (d) face; (e) cephalothorax, lateral; (f) carapace, dorsal.; (g) geographical variation of direction of the conductor tip of *C. australis*.

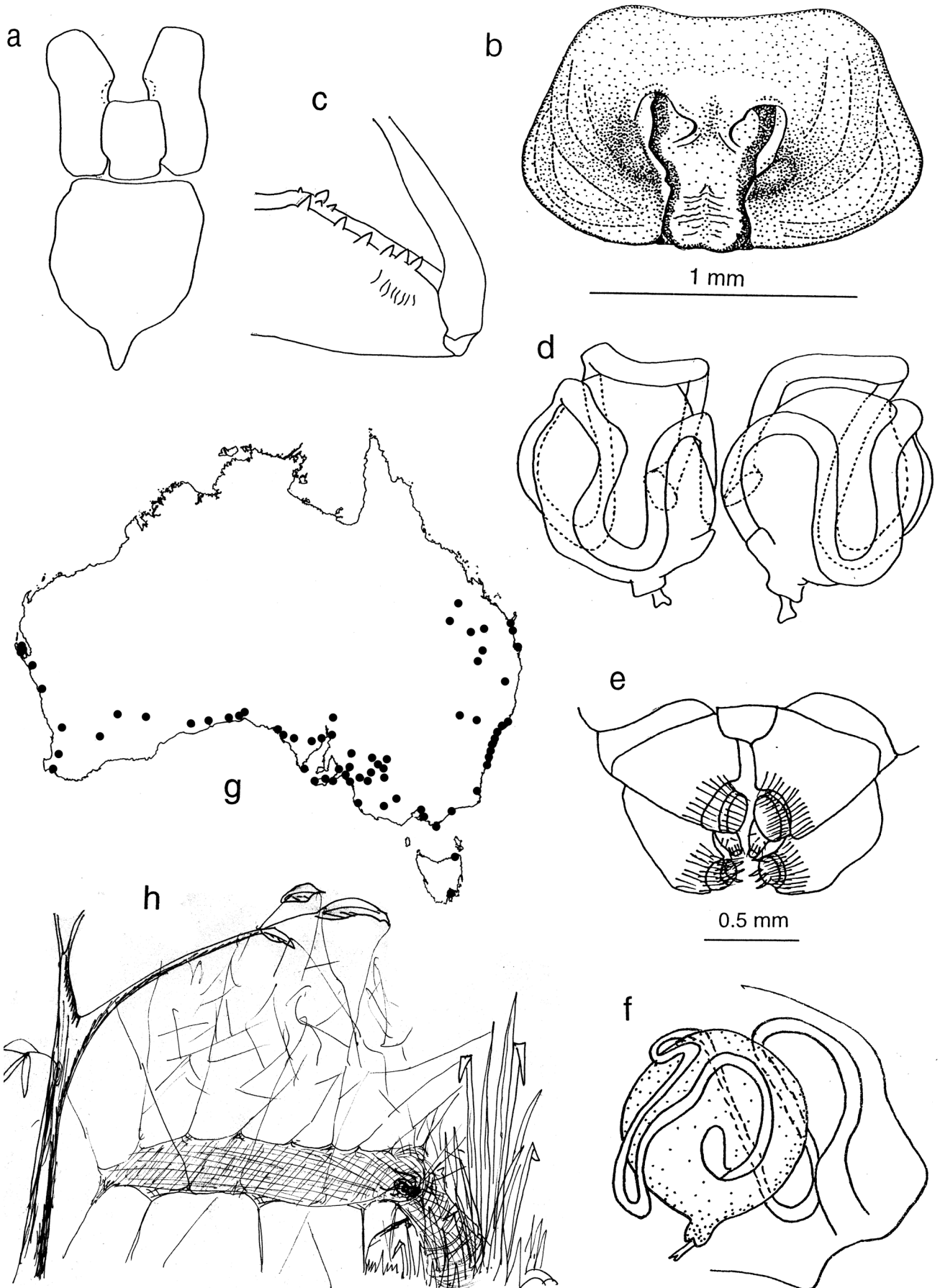

Figure 7. *Corasoides australis*: (a) sternum, labium and maxillae, ventral; (b) epigyne, ventral; (c) chelicera, male; (d) female internal genitalia, dorsal; (e) spinnerets, ventral; (f) female genitalia, lateral from centre; (g) distribution; (h) web.

114°44'E, 09 Oct 1993, M. Humphrey, KS.71827; 1♂, 1 juv, Collie, 33°21'S 116°09'E, 03 Oct 1993, M. Humphrey, KS.71828; 1♀, Zanthus, 31°02'S 123°34'E, H. Rose, KS.71829; 1♀, Peron NP, 25°16'S 113°43'E, Oct 1993, M. Humphrey, KS.71830; 1♀, 165 km N Geraldton, 27°21'S 114°04'E, 07 Oct 1993, M. Humphrey, KS.71832 (AM). 1♀, 8 km W Kalgoorlie, 30°45'S 114°23'9"E, Dec 1981, D. Hirst ARA5322 DH254 (SAM). 1♂, Edel Land, 26°10'40"S 113°13'30"E, 20 Aug. 1989, S. Harold, 92/8; 2♂♂, Carrarang Stn False Entrance well, 26°23'S 113°19'E, 21 Aug. 1970, A. Baynes, 92/4; 1♂, 1♀, Greenough, 28°57'S 114°44'E, 21 Aug. 1979, R. P. McMillan, 92/5-6; 1♂, Greenough Lucy Beach, 28°57'S 114°44'E, 27 Sept. 1979, R. P. McMillan, 92/41; 1 juv, Lake Cronin, 32°22'15"S 119°49'30"E, Feb. 1981, W. Humphreys *et al.*, 44/9; 1♀, 14 km E of Black Point, 34°25'30"S 115°41'30"E, 3–8 Dec. 1985, S. A. Harold, 92/22 (WAM).

Diagnosis. Male palpal cymbium with long digitiform portion but less than twice the length of the bulb diameter and often bent almost 90°. Conductor distinctly T-shaped, tip spine-like (Fig. 9b), unlike blunt tip of *C. motumae* sp. nov. and lacking flange of *C. occidentalis* sp. nov. Female epigyne with no lateral extension of the scape. Insemination ducts highly convoluted and looping over the surface of the spermathecae.

Description. Medium sized spider. **Carapace.** Type specimen light to reddish tan, head region and chelicerae darker. Little to no pattern, black edging surrounding eyes. **Abdominal pattern.** Basic dorsum pattern in most material examined (Figs 2, 5a–b). In the presumed syntype the pattern is less distinct (Fig. 2a); the central region is almost as dark as the background to the spots and the cream dorsolateral stripes do not have a definite boundary (Fig. 2a). In the female figured by Butler (1929), the basic pattern is darker, the dorsolateral stripes and two pairs of pale spots are very distinct but the rest of the dorsal surface is very dark, obscuring the central stripe (Fig. 2b).

Male. CL 5.8 (4.1–5.3), CW 4.5 (3.3–4.5), abdomen of type misshapen, HW 3.5, EpGW 1.7, MOQ L 0.8, MOQAW 0.6, MOQPW 0.7, SL 3.1, SW 2.8, ML 2.5, MW 1.1, LL 1.3, LW 1.0, ChelL 4.1 (2.6–4.5), ChelW 1.4 (1.2–1.3), clypeus height 0.6. **Cephalothorax.** Sternum longer than wide, bluntly pointed posteriorly. Labium slightly longer than wide, basally notched. **Chelicerae.** Robust. cheliceral teeth: very variable (Fig. 8a–j), even between left and right of one specimen (Fig. 8d,f). retromarginal 6(3), promarginal 4(3) Transverse ridges between teeth margins. Fangs with serrations. **Legs.** Leg lengths and spination of the presumed syntype cannot be given because of the separation or absence of all its leg segments. Leg lengths and spination given here are those of KS.71823 from Lakes NP (Victoria). This specimen is a similar size to the presumed syntype. Leg lengths

	I	II	III	IV	Palp
femur	6.2	4.5	4.3	8.6	4.4
patella	2.0	1.7	1.6	1.7	1.2
tibia	6.4	4.6	3.5	5.3	1.4
metatarsus	6.1	4.5	4.1	5.8	—
tarsus	2.2	1.7	1.5	2.2	4.1
total	22.9	17.0	15.0	20.7	11.5

Spination. Leg I: femur d1,3,2,3,3; tibia v2,2,2,2; metatarsus v2,2,2. Leg II: femur d1,3,3,3,3; tibia d1,1 v2,2,2; metatarsus v2,2,2 p1,1. Leg III: femur d3,2,3,2,3; tibia d1,1 v2,2,2; metatarsus d1,2,2,2 v2,2,2. Leg IV: femur d1,1,1,1,1,3,3; tibia v2,2,2 r1; metatarsus 2,1,1,2 v1,1,1,1,2. Palp: femur d1,1,1,2; tarsus several. **Male palp.** Digitiform portion of cymbium moderately long, about twice the length of the

diameter of the bulb. Retroventral apophysis present. Ventral apophysis large, curved towards bulb to hold embolus, one side with bulging membranous portion. Retrolateral apophysis long, spine-like, curving initially retrolaterally and then down towards its base. Embolus long, spine-like, originating retrolaterally. Conductor distinctly T-shaped. Conductor tip fine, pointed, mostly straight. Trichobothria on cymbium: single row of 4–5. **Abdomen.** A tail of small spigots is present on the anterior lateral spinnerets (Fig. 3b,c).

Female, similar to male. The following description is based on the female specimen figured by Butler (1929). CL 5.7 (3.9–6.1), CW 4.1 (3.0–4.2), AL 5.2, AW 3.7, HW 3.5, EpGW 1.7, MOQ L 0.8, MOQAW 0.6, MOQPW 0.7, SL 3.0, SW 2.7, ML 2.3, MW 1.0, LL 1.2, LW 1.2, ChelL 3.3, ChelW 1.9, clypeus height 0.6. **Chelicerae.** Teeth 5(6), 4(3). Leg lengths

	I	II	III	IV	Palp
femur	6.3	5.7	4.9	6.2	3.1
patella	2.2	2.1	1.7	1.9	1.1
tibia	6.5	4.6	3.5	5.6	1.7
metatarsus	6.4	4.8	4.5	5.9	—
tarsus	(2.2)	(1.7)	(1.6)	(2.2)	2.0
total	(23.6)	(18.9)	(16.2)	(21.8)	7.9

Tarsi were not present on the female specimen illustrated by Butler (1929). Figures in parentheses are for a Victorian female of similar size. Totals in parentheses include these substituted tarsal lengths. **Spination.** Leg I: femur d1,3,1,2 p1,1; tibia v2,2,2 p1; metatarsus v2,2,2 p1. Leg II: femur d1,2,2,1,2,3; tibia d1,1 v2,1,1,2; metatarsus d1,1 v2,2,2. Leg III: femur d3,3,2,2,3; tibia d1,1 v2,2,2; metatarsus d1,2,2,2, v2,2,2. Leg VI: femur d2,1,1,1,3; tibia v2,2,2; metatarsus d2,2,2,2, v2,2,2. Palp: femur d1,1,1,2; tarsus several. **Epigyne.** Length 1.0, width 1.6 for specimen figured by Butler (1929). Morphologically variable across range but generally with small genital openings and no lateral extension of the scape (Figs 7b, 11a–l). Surface smooth (The epigyne has been drawn as highly ridged by Lehtinen, 1967 but this mistaken appearance is caused by the insemination ducts being visible through the surface of the epigyne). Morphology of scape is often difficult to discern. Insemination ducts highly convoluted (5–7 bends), looping over the surface of the spermathecae (Figs 7d,f, 12a–h). Apparent variability is due to position of loops over spermathecae but loops per se maintain similar pattern. Spermathecae large and close together.

Habitat. *Corasoides australis* is found in temperate woodland, dry sclerophyll forest, heathland and semi-arid habitats. A specimen from Cooloola, Queensland, recorded as from rainforest is probably from wet sclerophyll forest. In all habitats it can reach high densities. Populations are often locally clumped and on embankments can be up to five tiered.

Distribution. Eastern Queensland and New South Wales south from Blackdown Tableland, through Victoria, Tasmania and South Australia to Eucla in Western Australia and north west to Shark Bay excluding the coastal margin of Western Australia from Dongara to Cape le Grande (Fig. 7g). A single specimen is recorded as being from Black Point, WA. *Corasoides australis* is sympatric with *C. occidentalis* sp. nov. in some areas, e.g. Toodyay, Collie and probably sites between Greenough and Cervantes.

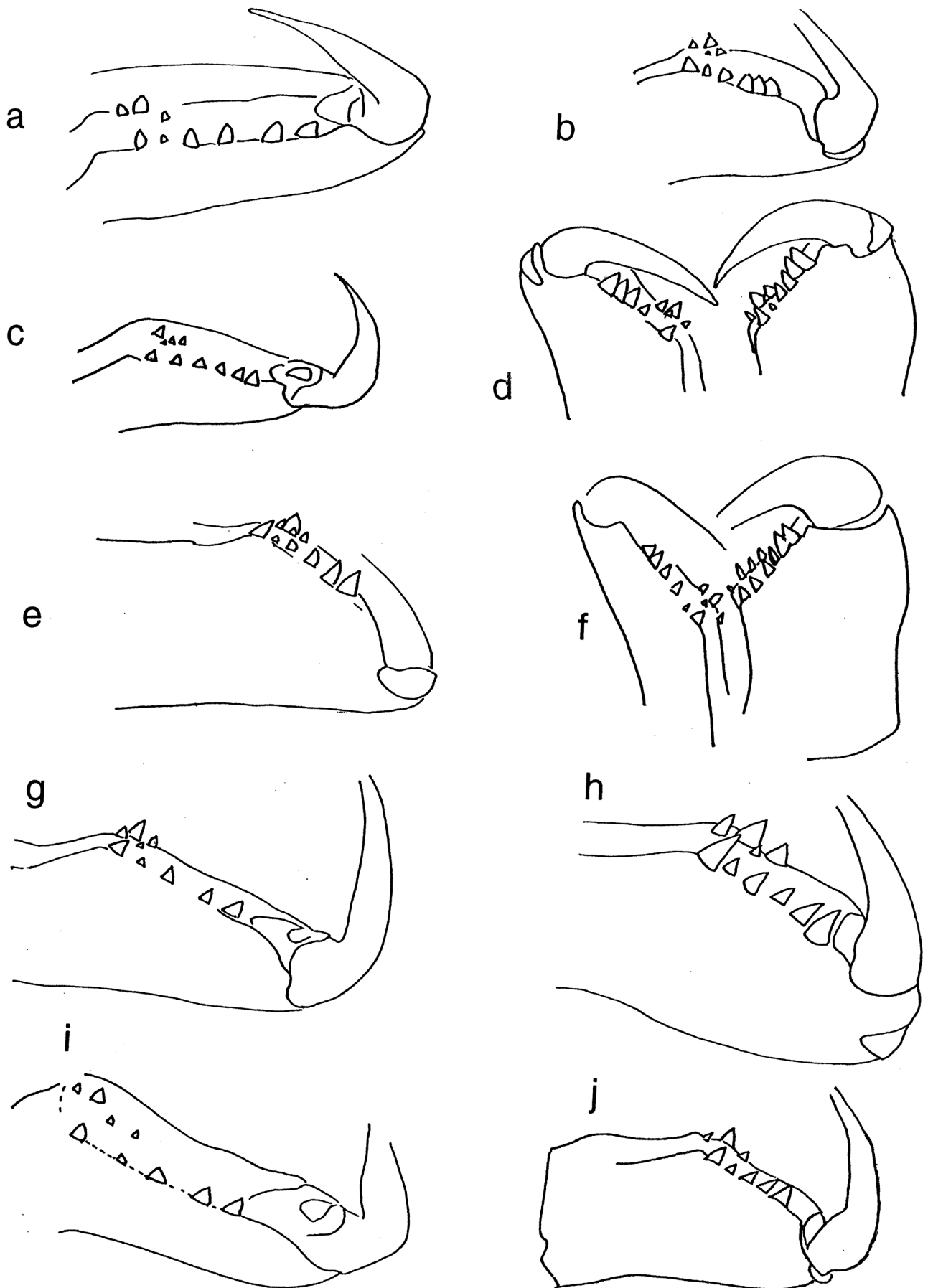

Figure 8. *Corasoides australis*, chelicerae: (a) male, Sydney, NSW; (b) female, Ballimore, NSW; (c) male, Lakes Entrance, Vic; (d) female, Bairnsdale, Vic; (e) male, Mt Clutha, Tas; (f) female, Opossum Bay, Tas; (g) male, Nullarbor, SA; (h) female, Morgan, SA; (i) male, Edeland, WA; (j) female, Kalgoorlie, WA. (Not to scale).

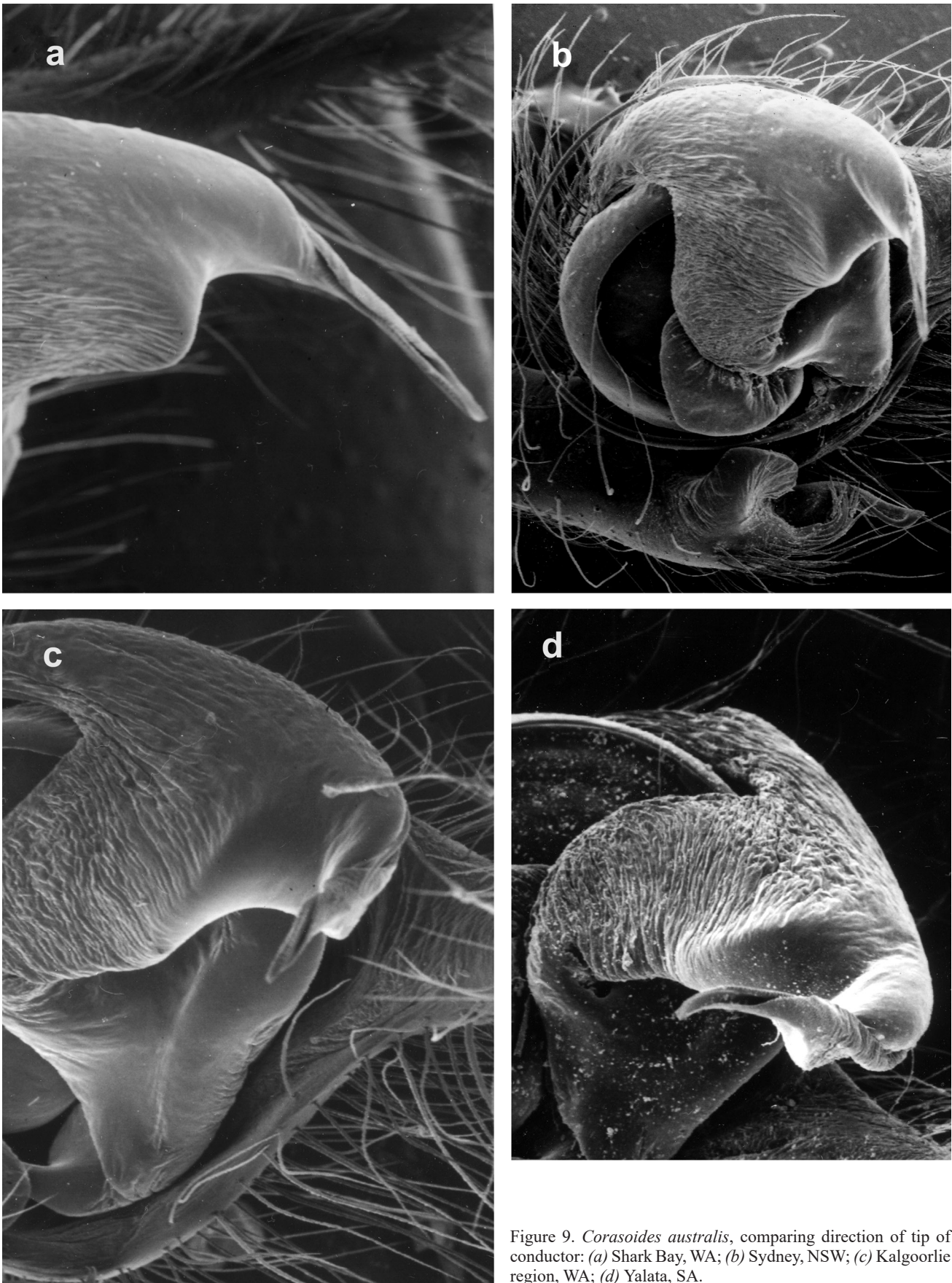

Figure 9. *Corasoides australis*, comparing direction of tip of conductor: (a) Shark Bay, WA; (b) Sydney, NSW; (c) Kalgoorlie region, WA; (d) Yalata, SA.

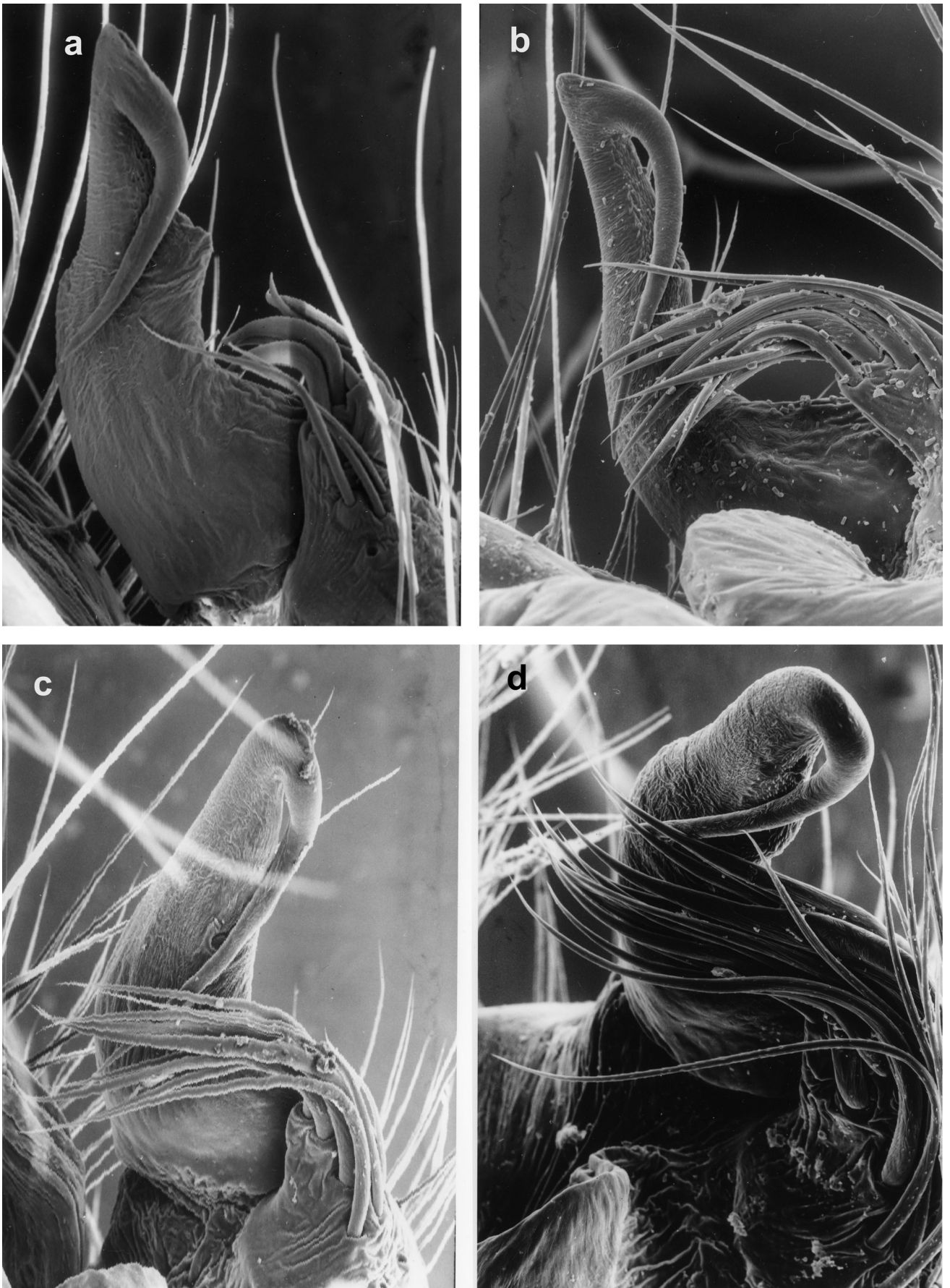

Figure 10. *Corasoides australis*, retrolateral apophysis; (a) Shark Bay, WA; (b) Sydney, NSW; (c) Hattah, Vic; (d) Wilsons Promontory, Vic.

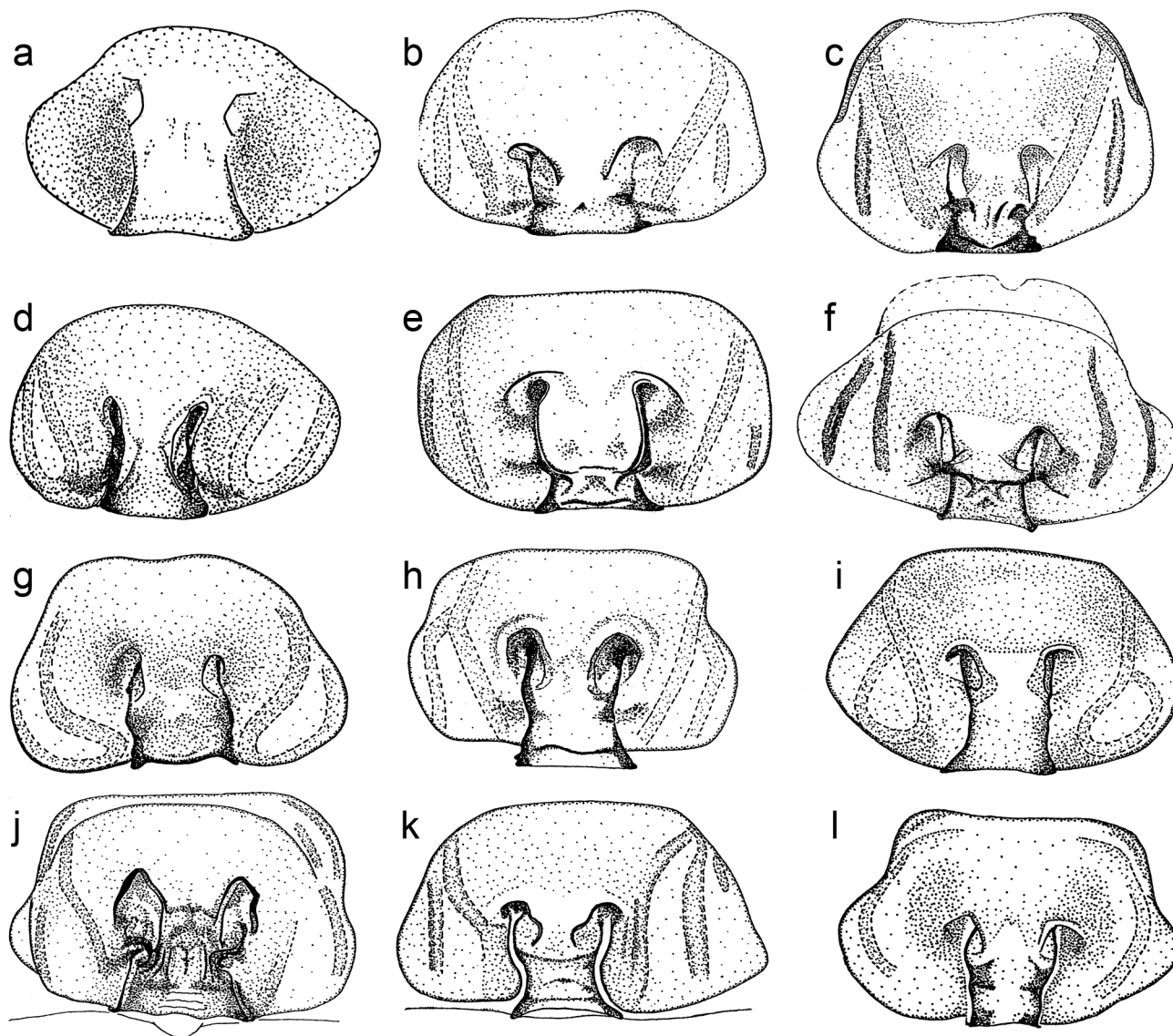

Figure 11. *Corasoides australis*, epigynes, ventral: (a) Blackdown Tableland, Qld; (b) Altonvale, Qld; (c) Morton Island, Qld; (d) Kalgoorlie, WA; (e) Gibraltar, NSW; (f) Sydney, NSW; (g) Jarradale, WA; (h) Ballimore, NSW; (i) Jervis Bay, NSW; (j) Bald Hill, WA; (k) Kangaroo Island, SA; (l) Opossum Bay, Tas.

Remarks. *Corasoides australis* is the smallest of the Australian species although there is overlap in size with other species. *Corasoides australis* probably reaches its largest size on and near Fraser Island and its smallest size in the arid inland of South Australia and Western Australia. Both adults and juveniles always dig a burrow. The male does not cohabit with the female at any time, nor is the epigyne plugged.

A cline can be distinguished by the angle of the conductor tip (Fig. 6g). On the north east coast of its distribution the tip is long and straight and projected retrolaterally. On the south east coast, the tip curves slightly more towards the base of the cymbium (Fig. 9b). Across the south the tip is bent over at more than 90° (Fig. 9d) but straightens out again in Western Australia (Fig. 9c) and going north so that specimens from the Shark Bay region (Fig. 9a) resemble those from Queensland and the Sydney region. This is shown diagrammatically in Fig. 6g. What appears now as a double east/west cline could possibly have once been a single north/south cline, which lost most of the intermediate representatives from the central Australian region. This

double East/West cline is also apparent in the appearance of the retrolateral apophysis which has a distinct peak on the apex in eastern and western specimens (Fig. 10a,b) but is lacking in the southern specimens (Fig. 10c,d)

There is also variation in the appearance of the female epigyne, particularly in the definition of the scape (Fig. 11a–l). However, this variation does not seem to follow any geographical pattern.

Corasoides angusi sp. nov.

Figs 13, 14

Holotype ♂, Kuper Ranges, 30 km NNE of Wau, PNG [Papua New Guinea], 7°05'S 146°45'E, 31 Oct 1996, M. Humphrey, M. Moulds, W. Angus, KS.71659 (AM). **Paratypes** as follows: 1♀, same data as holotype, KS.71660; 10♀♀, same data, KS.71662; 1♂, same data except collected Nov 1996, KS.71661 (AM).

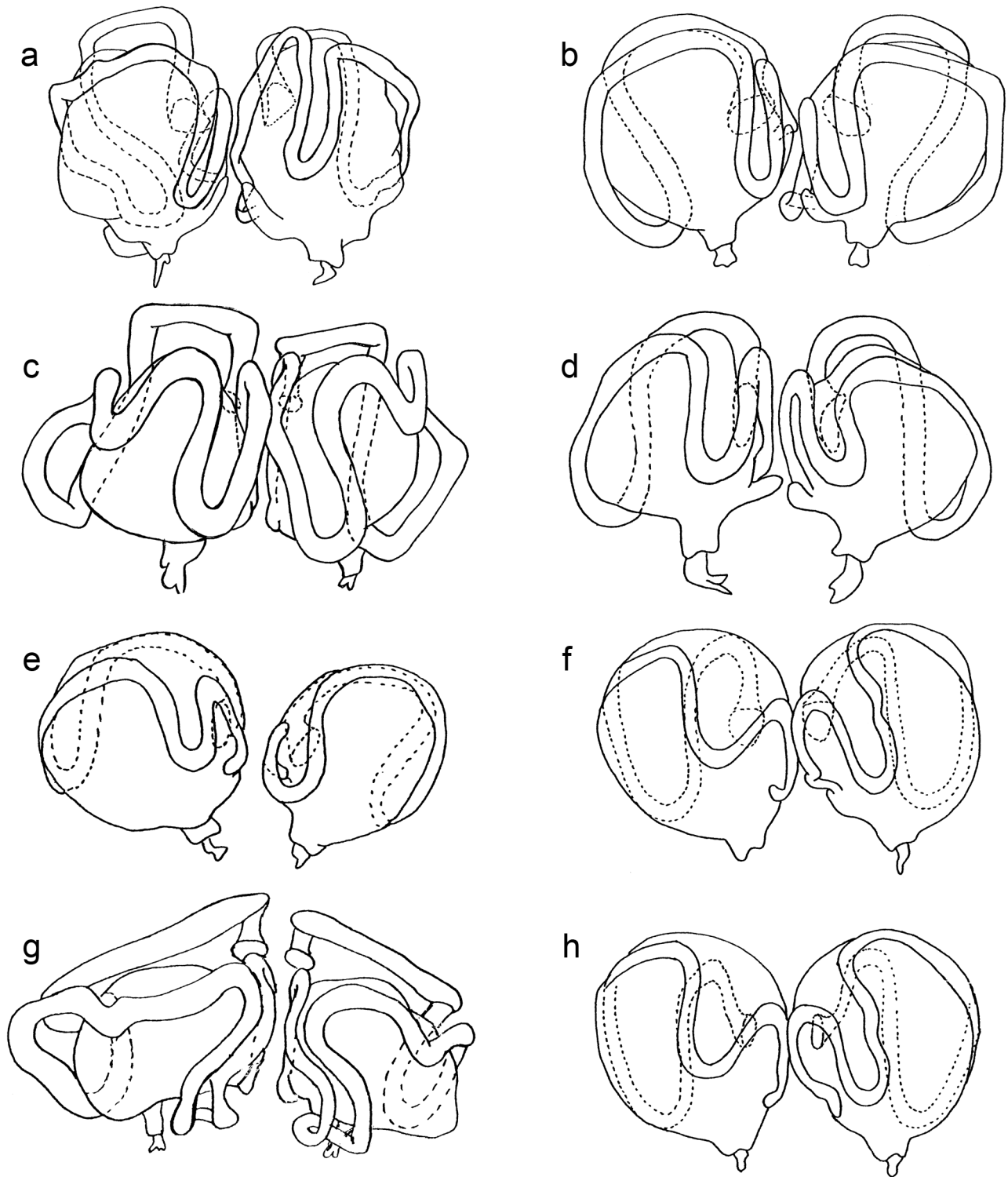

Figure 12. *Corasoides australis*, female internal genitalia: (a) Narayan, Qld; (b) Gibraltar, NSW; (c) Shark Bay, WA; (d) Sydney, NSW; (e) Kalgoorlie, WA; (f) Jervis Bay, NSW; (g) Nullarbor, SA; (h) Wilsons Promontory, Vic.

Other material examined. Body parts remaining from dissections and electrophoretic work from identified specimens, namely 1 pair male palps, 1 epigyne and pair chelicerae from female, data as for holotype (AM).

Diagnosis. This species differs in the male from the closely related *C. nimbus* sp. nov. by having a strongly hooked retrolateral apophysis tapering to a fine point rather than

a blunt, truncated hook and by the base of the embolus originating prolaterally rather than distally or retrolaterally. The female is distinguished by having only three bends (weakly convoluted) in the insemination ducts rather than at least five (strongly convoluted) in *C. nimbus* sp. nov. and *C. stellaris* sp. nov. Females of *C. angusi* sp. nov. cannot be readily distinguished externally from those of *C. nimbus* sp. nov.. However, the epigynes of both *C. angusi* sp. nov.

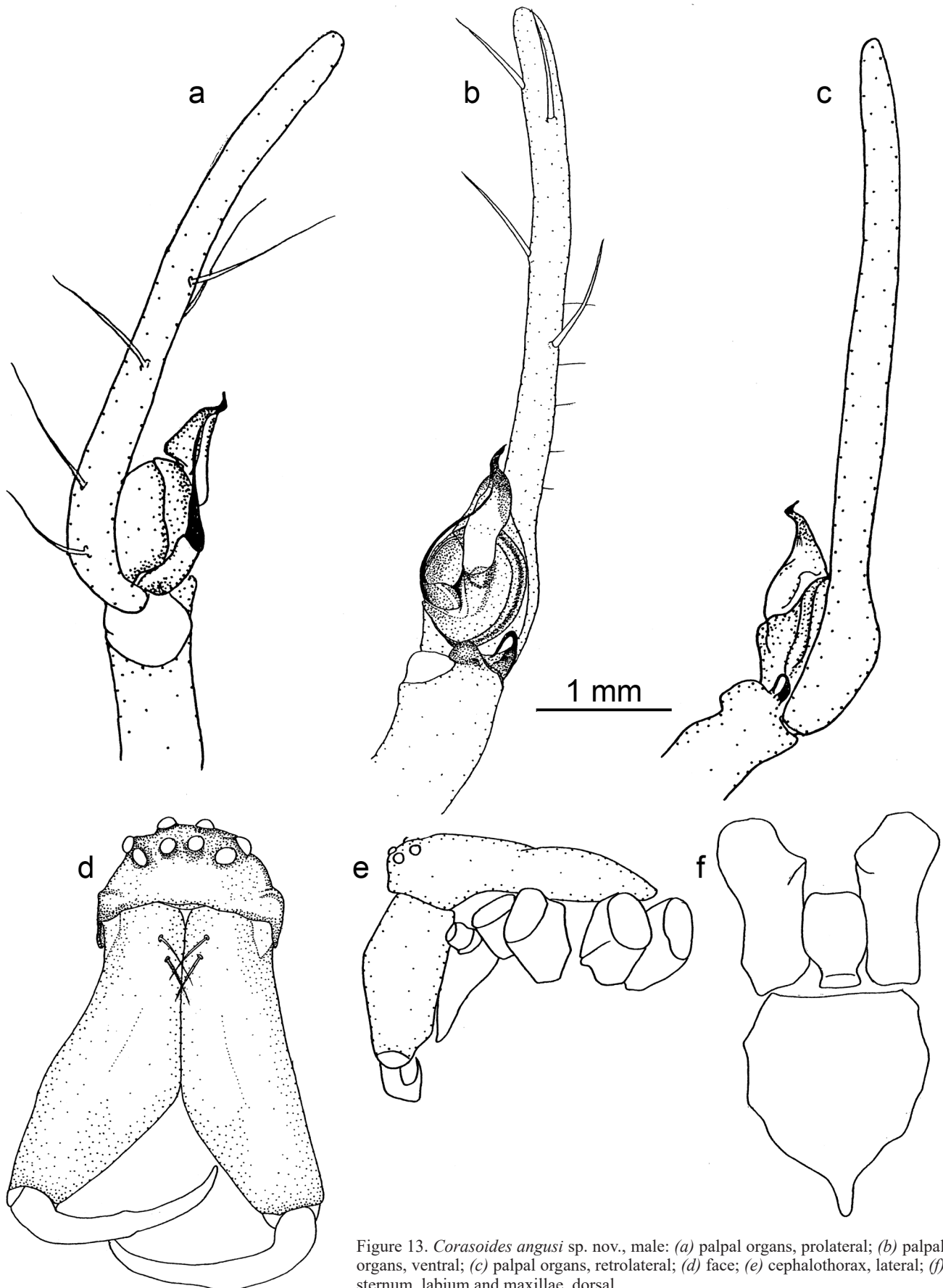

Figure 13. *Corasoides angusi* sp. nov., male: (a) palpal organs, prolateral; (b) palpal organs, ventral; (c) palpal organs, retrolateral; (d) face; (e) cephalothorax, lateral; (f) sternum, labium and maxillae, dorsal.

and *C. nimbus* sp. nov. differ from *C. stellaris* sp. nov. in having the lateral extension of the scape no more than half the width of the epigyne.

Description. Medium to large spiders. **Carapace.** Full pattern for genus but indistinct in some specimens. **Abdomen.** Distinct basic abdominal pattern.

Male (Figs 13a–f, 14b,d,f). CL 6.3 (6.5), CW 4.3 (4.5), AL 6.6, AW 3.2, HW 3.1, EpGW 1.9, MOQL 0.85, MOQAW 0.65, MOQPW 0.85, SL 2.9, SW 2.7, ML 2.4, MW 1.3, LL 1.3, LW 0.9, ChelL 4.4 (4.5), ChelW 1.6 (1.6), clypeus height 0.5. **Cephalothorax.** Sternum roughly equal in length and width, distinct posterior point, long ventrally projecting hairs. Labium longer than wide, notched basally. **Cheliceral teeth.** retromarginal 6(7), promarginal 4, subequally spaced, no fusions. No transverse ridges between teeth margins. Metatarsus IV particularly long, other leg lengths:

	I	II	III	IV	Palp
femur	11.9	9.3	9.4	12.1	4.5
patella	2.8	2.5	1.9	2.3	1.3
tibia	12.6	8.4	6.8	10.0	2.5
metatarsus	14.9	12.0	11.5	16.3	—
tarsus	6.1	4.1	3.9	5.1	4.0
total	48.1	36.3	33.4	45.8	12.3

Spination. Leg I: femur d3,3,1,1,1,1,1,3,1,3; tibia d3,3,3,3,3,1 v1,1,1,1,1,1,1,2; metatarsus d2,1,1,1,1,2 v2,2,2,3. Leg II: femur d3,3,2,3,1,3,3; tibia 1,1,1,1,1,2 v1,1,1,1,1,1,1,2; metatarsus d1,1,1,1,1,2v2,2,2,3. Leg III: femur d3,2,1,3,3,2,2; tibia d1,1 v1,1,1,1,1,1,1,2; metatarsus d2,2,2,2,2,2, v2,2,2,2. Leg IV: femur d2,2,3,3,1; tibia d1,1,1, v1,1,2,1,1,1; metatarsus d2,2,2,2,2,2,2,2, v1,2,2,1,1,1,1,2,2. Palp: femur d1,3,v1; tibia d1; tarsus several. **Male palp.** Digitiform portion of the cymbium very long- cymbium length about six times diameter of bulb. Retroventral apophysis absent. Ventral apophysis lobe-like, not enclosing any extension of the intersegmental membrane. Retrolateral apophysis long, hook-like, tapering and curving initially towards bulb and then pointing towards its base. Embolus arises prolaterally, enters conductor prolaterally. Conductor stalked, wide basally. Conductor tip pointed, twisted but with less than one rotation. Conductor tip without ridges and pointing towards cymbium, i.e. dorsally (Fig. 13a–c). Trichobothria on cymbium: single row of at least six evenly spaced on prolateral to dorsal line, decreasing in length proximally. **Abdomen.** Anterior lateral spinnerets with tail of small spigots.

Female (Fig. 14a,c,e,f), similar to male. CL 6.3 (5.6–7.0), CW 4.8 (4.6–4.9), AL 7.6, AW 5.1, HW 3.3, EpGW 1.8, MOQL 0.91, MOQAW 0.70, MOQPW 0.85, SL 3.3, SW 2.7, ML 2.5, MW 1.3, LL 1.4, LW 1.0, ChelL 3.6 (3.2–3.7), ChelW 1.6, clypeus height 0.4. Cheliceral teeth as for male. Leg lengths:

	I	II	III	IV	Palp
femur	8.8	7.3	6.0	7.5	4.0
patella	2.5	2.4	2.0	2.3	1.3
tibia	9.0	6.4	4.3	6.9	3.5
metatarsus	9.0	7.1	7.0	9.0	—
tibia	3.8	2.9	2.4	3.0	3.3
total	29.3	26.0	21.6	28.6	12.0

Spination. Leg I: femur d2,1,2,1,1,2,4; tibia; metatarsus d2 v2,1,2,2,1,1,2. Leg II femur d3,1,3,2,1,1,2,3; tibia d1,1,2 v1,1,2,2. Leg III: femur d3,3,1,2,1,2,4; tibia d1,1,1,3 v2,1,1,1; metatarsus; d2,1,1,1,1,2 v1,2,2,2. Leg IV: femur d1,2,1,1,2,1,2,3; tibia d2,2,2,2 v2,2,1,1,1; metatarsus; d1,1,1,1,1,2,4 v1,1,1,1; Palp; femur; patella d1,1, tibia d1,1, p1; tarsus several. Trichobothria on first tarsus: at least eight, evenly spaced, decreasing in length proximally. **Epigyne** (Fig. 14a). Height 0.8, width 1.3. Smooth, no ridges or beaks. Genital openings on transverse midline. Scape stalk short, almost equal in width to diameter of a genital opening. Lateral extensions of scape wide and extending almost to lateral margins of genital openings. Anterior and lateral surfaces of epigyne covered in long, posteriorly directed hairs. Insemination ducts, weakly convoluted, proceed anteriorly from genital openings with three bends, small diverticula at site of entry into spermathecae (Fig. 14c,e).

Habitat. High altitude rainforest, in particular, mist forest. Webs with retreat into crevices in tree trunks, earthen embankments and fallen logs, up to 1.5 m from ground level.

Distribution. Common in Kuper Ranges, 30 km NNE of Wau, PNG, 7°05'S 146°45'E, Papua New Guinea (Fig. 14f).

Etymology. Named after Warrick Angus who enthusiastically helped to collect the type series.

Corasoides cowanae sp. nov.

Figs 15, 16

Holotype ♂, S.E. slope of Mt Akrik (Mt Ian), 15 km NW Tabubil WP, 5°10'S 141°09'E, 1625 m, PAPUA NEW GUINEA, Nov. 1996, M. S. Moulds & M. Humphrey, KS.71834 (AM). **Paratypes** as follows: 3♂♂, 1♀, SE slope Mt Akrik (Mt Ian) 15 km NW Tabubil, 1625 m 5°10'S 141°09'E, 9 Oct. 1993, M. S. Moulds & S. Cowan, KS.71833 (AM); 1♂, 5♀♀ S.E. slope of Mt Akrik (Mt Ian), 15 km NW Tabubil WP, 5°10'S 141°09'E, 1625 m, Nov. 1996, M. Humphrey & M. S. Moulds, KS.98072 (AM).

Diagnosis. CL less than 3.0 mm. Enlarged anterior retromarginal cheliceral teeth in male. (Fig. 16b,c). Conductor tip spout-like, pointing retrolaterally (Fig. 15c). Can be distinguished from closely related *C. nebula* sp. nov. by the presence of a simple, sclerotized retrodorsal tibial apophysis on the male palp and in the female by the genital openings of female epigyne which are positioned and directed posteriorly (Fig. 16g).

Description. Small spider. **Carapace.** Cream edged with dark tan. Other specimens cream to light tan. **Abdomen.** Basic pattern in holotype reduced to one pair of distinct dorsal spots (Fig. 15d). Otherwise variable, from basic pattern to dark with short dorsolateral stripe and indistinct central strip.

Male (Figs 15, 16a–c, i). CL 2.8 (2.1), CW 2.0 (1.6), AL 3.3 (2.3), AW 2.3 (1.5), HW 1.3, EpGW 0.9, MOQL 0.45, MOQAW 0.38, MOQPW 0.80, SL 1.3, SW 1.2, ML 1.1, MW 0.5, LL 0.5, LL 0.5, ChelL 2.0 (1.1), ChelW 0.7 (0.4), clypeus height 0.3. **Cephalothorax.** Sternum roughly equal in length and width, blunt posterior point. Labium roughly equal in length and width, basally notched. **Chelicerae.** Long. Fangs

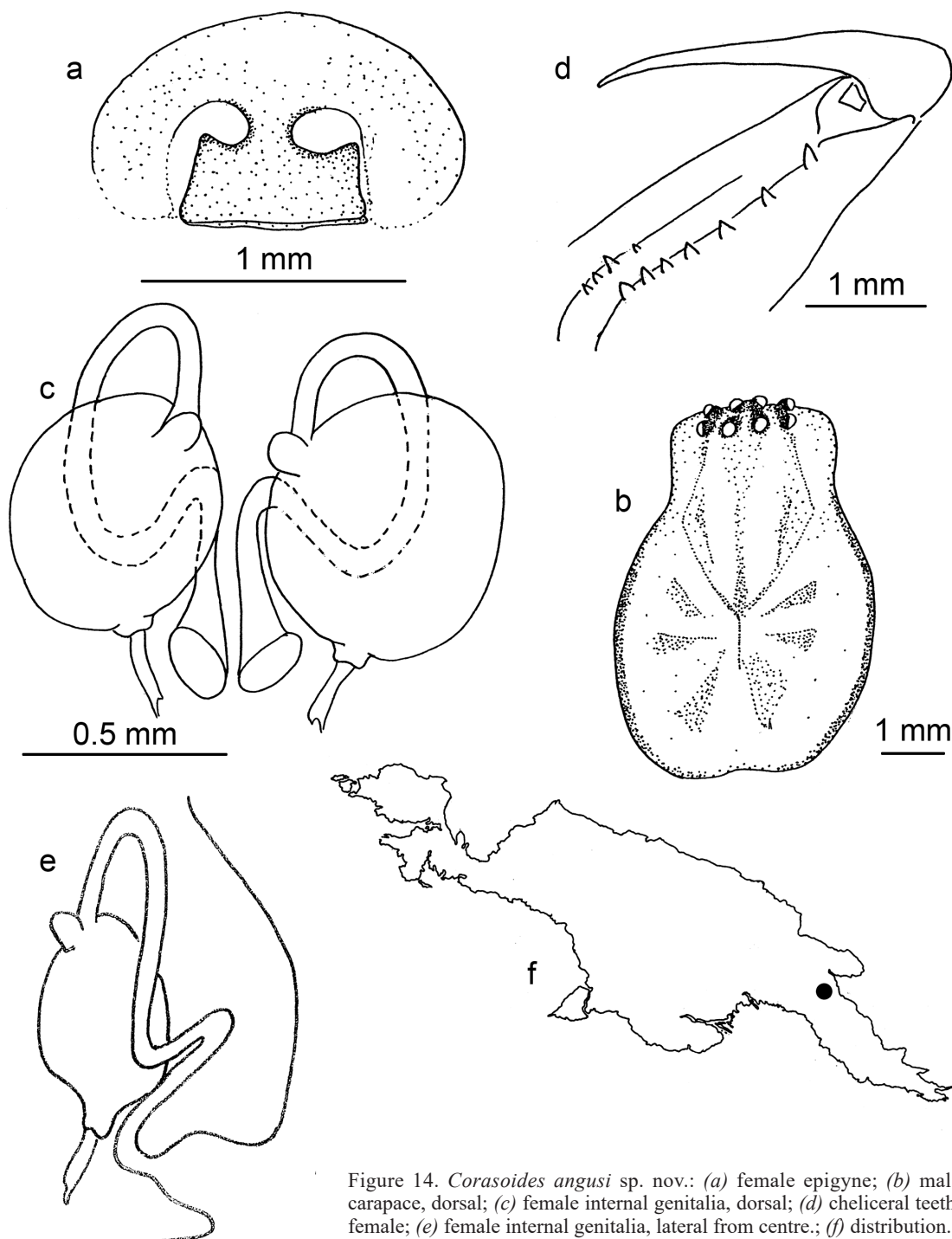

Figure 14. *Corasoides angusi* sp. nov.: (a) female epigyne; (b) male carapace, dorsal; (c) female internal genitalia, dorsal; (d) cheliceral teeth, female; (e) female internal genitalia, lateral from centre.; (f) distribution.

without serrations (Fig. 16a). Cheliceral teeth (Fig. 16b,c) retromarginal 8 (7), distal tooth greatly enlarged and skewed retrolaterally, penultimate tooth less so, promarginal 3(4). No transverse ridges between rows of teeth. **Legs.** Banded, particularly ventrally. Leg lengths:

	I	II	III	IV	Palp
femur	4.6	3.9	3.6	4.7	3.4
patella	0.9	0.9	0.8	0.8	0.6
tibia	4.8	3.3	2.8	4.3	1.3
metatarsus	5.4	4.2	4.3	6.4	—
tarsus	3.3	2.1	1.8	2.7	4.4
total	19.0	14.3	13.3	18.9	9.6

Spination. Leg I: femur d2,2,3,3,2; tibia v2,2,2; metatarsus v1,1,1,2. Leg II: femur d1,1,1; tibia v2,2,2; metatarsus v1. Leg III: femur d1,1,1,1,1,1,1; patella d1; tibia d1,1,1,1,2 v2,2; metatarsus d2,2,2,4 v2,1,1,1,2. Leg IV: femur d1,1,1,1,1,1,3 v1; tibia d1,1,1,2 v1,1,2; metatarsus d2,2,2,2,2, v2,2,2,2,2. Palp: femur d1,2; d1; tibia d1 v1; tarsus several. **Male palp.** Digitiform portion of cymbium long, cymbium length at least four times the diameter of bulb. Retroventral apophysis absent. Retrodorsal apophysis present, simple and sclerotized. Retrolateral and ventral apophysis closely aligned with tuft of hairs passing between. Ventral apophysis erect, sclerotized, not enclosing any intersegmental membrane. Retrolateral apophysis with high base, spine-like portion

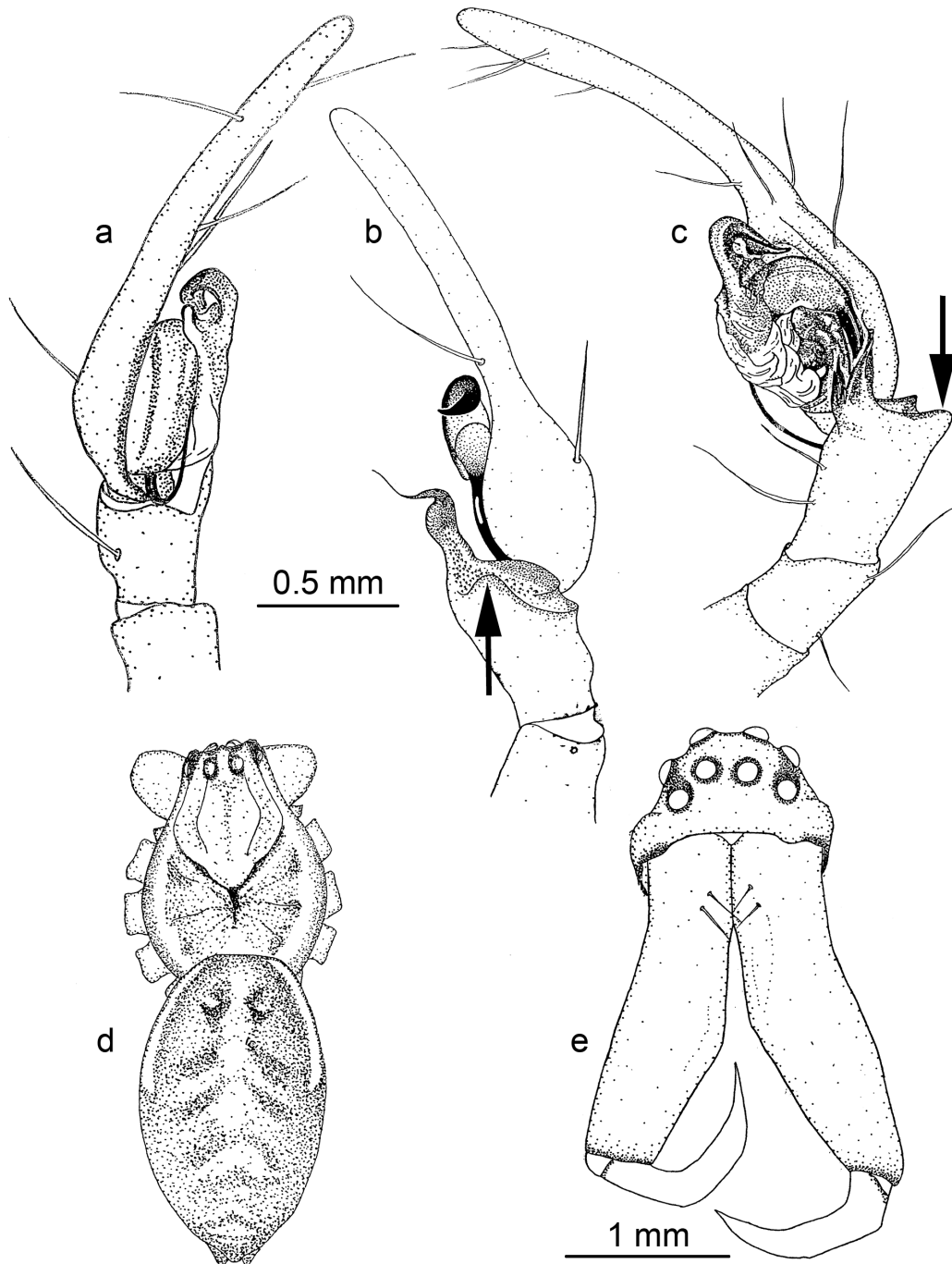

Figure 15. *Corasoides cowanae* sp. nov. male: (a) palpal organs, prolateral; (b) palpal organs, ventral; (c) palpal organs, retrolateral; (d) carapace and abdomen, dorsal; (e) face. Arrows indicate ventral apophysis.

long, very fine, pointed away from bulb retrolaterally and then curving slightly apically. Embolus arises retrolaterally. Conductor stalked, unequally bifid with lightly sclerotized finger-like projection partially hidden behind larger, heavily sclerotized portion. Major sclerotized portion unridged, deeply curved almost forming circle. Trichobothria on cymbium in single row of 4 decreasing in length basally. **Abdomen.** No tail of spigots on anterior spinnerets.

Female (Fig. 16d–i), similar to male. CL 2.4 (2.2), CW 1.9, AL 3.4, AW 2.5, HW 1.1, EpGW 0.8, MOQL 0.45, MOQAW 0.3, MOQPW 0.42, SL 1.2, SW 1.2, ML 1.0, MW 0.5, LL 0.5, LW 0.4, ChelL 1.5 (1.2), ChelW 0.6, clypeus height

0.2. **Cheliceral teeth.** Retromarginal 7, no enlargement as in male; promarginal 4 (Fig. 16d). Leg lengths:

	I	II	III	IV	Palp
femur	4.1	2.8	2.7	3.8	1.4
patella	0.8	0.7	0.7	0.8	0.4
tibia	4.0	2.3	2.1	2.7	0.9
metatarsus	3.5	2.8	3.3	4.2	—
tarsus	2.4	1.5	1.3	1.7	1.3
total	14.8	10.1	7.5	13.1	3.0

Spination. Leg I: femur d1,2,2,2; metatarsus v1,2,2. Leg II: femur d1,2,1,1,3; tibia d1,1,1,1 v2,2; metatarsus d1,1,1,1,2

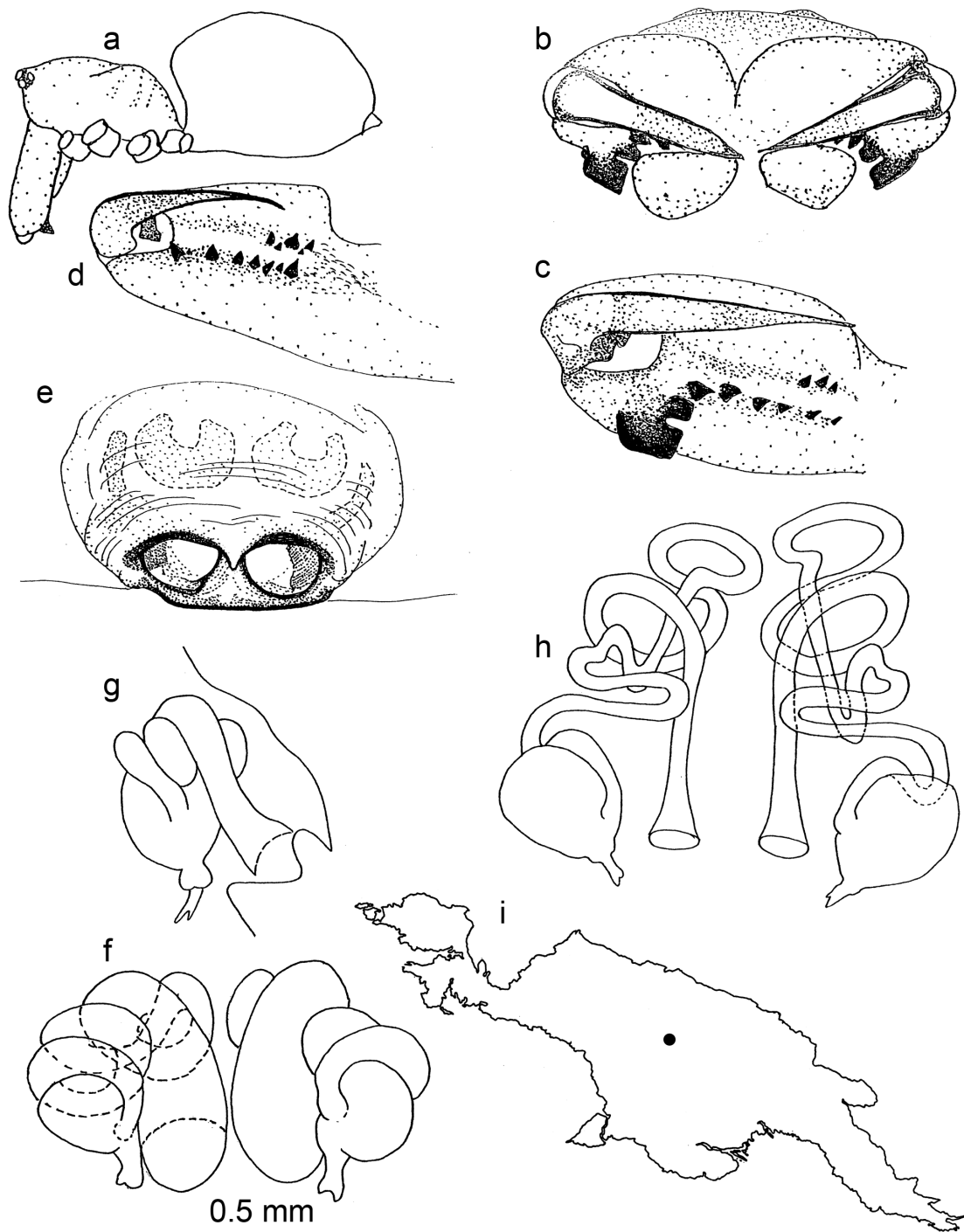

Figure 16. *Corasoides cowanae* sp. nov.: (a) male cephalothorax and abdomen, lateral; (b) male chelicerae and maxillae, ventral; (c) male chelicera; (d) female chelicera; (e) epigyne; (f) female internal genitalia, dorsal; (g) female genitalia, lateral, from centre; (h) female internal genitalia, dorsal exploded view; (i) distribution.

v1,1,1,2. Leg III: femur d1,2,1,2,1,2,1,2; tibia d1,2,1,2 v1,1,1; metatarsus d2,2,2,3 v1,1,1. Leg IV: femur d1,1,1,1,1,1; tibia d1,1,1,1; metatarsus d2,2,2,2,2,4 v1,1,1,1,1. Palp: femur d1,1,2 v2; tibia v2; tarsus several. Trichobothria on 1st tarsus: single row of four, decreasing in length proximally. **Epigyne** (Fig. 16e). Wider than long, wrinkled anterior. Beak projecting posteriorly over anterior of scape stalk. Scape stalk less than diameter of one genital atrium. Lateral extension of scape extending to lateral margin of genital atria. Genital openings and atria posterior. Insemination ducts proceed directly anteriorly, highly convoluted and coiled (at least

three rotations with a change in direction and several bends) (Fig. 16f,h). No diverticula.

Habitat. Tropical rainforest, altitude 1,625 m. Webs common on embankments with retreats in earthen crevices or amongst leaf litter.

Distribution. Known only from the type locality, Mt Akric, Western Province, Papua New Guinea. (Fig. 16i)

Etymology. Named after Sally Cowan who collected most of the type series.

***Corasoides motumae* sp. nov.**

Figs 17, 18, 19b–d

Holotype ♂, Clyde Mountain, NSW [New South Wales], 35°33'S 150°00'E, 30 March 1999, Helen Smith, M. Humphrey, KS.71838 (AM). **Paratypes** as follows: 1♀, data as for holotype; 3♂♂, 1♀, Monga, NSW, 35°34'S 149°56'E, 30 March 1999, H. Smith, M. Humphrey, KS.71839 (AM).

Other material examined. 2♀♀, data as for Monga paratypes; 2♀♀ (remains, including 2 complete abdomens, from electrophoretic work), same data as holotype (AM).

Diagnosis. Chelicerae and head region dark, almost black. No differentiation in colour between ocular region and rest of head. Cymbium relatively short for genus, less than 2.5 times the diameter of the bulb. Distinguished from *C. australis* by blunt conductor tip (Figs 17b, 19b), ventral apophysis lobe-like and completely sclerotized (Fig. 17b,e), and stalk of scape with bulbous portion anterior to genital openings (Fig. 18b)

Description. Medium to large spider. **Carapace.** Head region and chelicerae almost black, indiscernible from colouring surrounding eyes (Figs 17d, 18a,e). Dark colour, but less intense, extending into the thoracic region of the dorsal carapace. **Abdomen.** Basic pattern but indistinct. Central pale stripe very wide and largely obscuring rows of spots.

Male (Figs 17, 18a,c,e,g, 19b–d). CL 7.4 (6.9), CW 5.2 (2.5), AL 6.3, AW 3.8, HW 3.4, EpGW 1.8, MOQL 0.73, MOQAW 0.64, MOQPW 0.85, SL 3.9, SW 3.0, ML 2.7, MW 1.3, LL 1.5, LW 1.1, ChelL 3.7 (3.3), ChelW 1.5 (1.3), clypeus height 0.5. **Cephalothorax.** Sternum longer than wide, distinct point posteriorly with bunch of hairs at point (Fig. 18c). Labium as long as wide, notched basally, slightly rebordered. **Chelicerae.** Cheliceral bristles reduced, not crossing in front (Fig. 17d). Teeth retromarginal 5(6), promarginal 3(4). Transverse ridges present between margins. Fangs with serrations. Leg lengths:

	I	II	III	IV	Palp
femur	8.3	7.3	6.3	8.0	5.5
patella	3.2	2.5	2.1	2.1	2.1
tibia	9.3	6.5	4.8	7.4	2.1
metatarsus	8.5	6.4	6.9	9.0	—
tarsus	3.3	2.1	2.0	2.3	4.4
total	32.5	24.8	22.0	28.8	14.1

Spination. Leg I: femur d1,1,3,1,1,1,3; tibia v2,1,2,2; metatarsus v1,1,2. Leg II: femur d3,1,3,1,1,1,3; tibia d1,1 p1; metatarsus d1,1 v2,2,2. Leg III: femur d3,3,3,3,3; tibia d1,2,3 v2,2,2; metatarsus d1,2,2,2, v2,2,2. Leg IV: femur d1,2,1,1,1,1,3; tibia d1,1,1 v2,2,2 p1 r1; metatarsus d3,3,3,3,3 v2,1,1,2,2. Palp: femur d1,1,2,3; tarsus several. Row of 7 trichobothria on 1st tarsus. **Male palp.** Digitiform portion of cymbium relatively short for this genus—cymbium length less than 2.5 times diameter of bulb. Ventral apophysis lobe-like, not enclosing any intersegmental membrane. Retrolateral apophysis broad, flattened, curving retrolaterally, with terminal spine-like portion pointed back towards bulb (Figs 17e, 19c). Origin of embolus basal. Conductor roughly T-shaped, covering most of bulb. Conductor tip twisted, with ridges (Figs 17a–c, 19b,d). Single row of 5 trichobothria on cymbium.

Female (Figs 18b,d,f), similar to male. CL 7.4 (7.9), CW 5.1 (5.0), AL 7.6, AW 5.1, HW 3.8, EpGW 1.8, MOQL 0.77, MOQAW 0.65, MOQPW 0.86, SL 3.6, SW 2.9, ML 2.4, MW 1.5, LL 1.4, LW 1.3, ChelL 4.0 (3.9), ChelW 1.5 (1.4), clypeus height 0.4. **Chelicerae.** Teeth as for male. Leg lengths:

	I	II	III	IV	Palp
femur	7.5	8.6	6.3	7.9	3.3
patella	2.5	2.6	2.3	2.4	1.3
tibia	7.4	5.1	4.6	6.9	2.1
metatarsus	7.0	6.3	5.1	7.1	—
tarsus	2.8	2.1	2.3	2.5	3.3
total	27.1	22.8	20.5	26.8	9.9

Spination. Leg I: femur d1,1,3,1,3,3; tibia v2,2,1,1,2; metatarsus v2,2,2. Leg II: femur d3,4,3,3,3; tibia d1,1,1 v2,2,2 p1,1; metatarsus d1,1 v2,2,2. Leg III: femur d3,3,2,2,1,3,3; tibia d1 v2,2,2 p1,1; metatarsus d3,3,2,2 v1,1,2,3; Leg IV: femur d3,3,3,3,3; tibia d1,1,1 v2,2,2 p1 r1,1; metatarsus: d3,3,3,3,3, v1,1,1,1,2. Palp: femur d1,1,2,3; tarsus several. Trichobothria on 1st tarsus: single row of 6–7 decreasing in length proximally. **Abdomen.** Anterior lateral spinnerets with tail of small spigots. **Epigyne** (Fig. 18b). Length almost equal to width. No ridges or beaks. Stalk of scape bulbous posteriorly, narrow, less than half the diameter of the genital atria. Lateral extension of scape short extending to halfway across apparent genital atrium area. Origins of insemination ducts almost posterior. Insemination ducts very weakly convoluted (1 bend) (Fig. 18d,f). No diverticula. Spermathecae touching (Fig. 18d).

Habitat. Cool temperate rainforest and wet sclerophyll forest. Webs commonly found in crevices in dead tree trunks, fallen timber and rubble. Some webs in the wet sclerophyll descended into crevices in the ground or leaf litter. Web heights from ground level to 1.5 m.

Distribution. Monga and Clyde Mountain, southeastern New South Wales (Fig. 18g).

Etymology. Named after Dr Helen Motum Smith who collected the first specimens known to me.

***Corasoides mouldsi* sp. nov.**

Figs 20, 21

Holotype ♂, Windsor Tablelands, Qld [Queensland], 16°16'S 145°02'E, July 1995, M. Humphrey M. Moulds, KS.71835 (AM). **Paratypes** as follows, all Queensland: 1♀ KS.71836 (AM), 5♀♀ KS.71663 (AM), 2♂♂ and 3♀♀ KS.71664 (AM), same data as holotype; 2♀♀, rainforest near forestry hut Windsor Tableland, 18 Apr 1994, Judy Thompson & M. Moulds, 5147, KS.71689 (AM); 1♀, same data, 5146 KS.71690 (AM); 1♂, 1♀, same data, 5148, 5149, KS.71687 (AM); 1♀, same data, 5145, KS.71688 (AM); 1♂, Windsor Tableland on highest point, 16°14'S 145°00'E, 22 July 1995, Thompson, Moulds, Olive, Tio, MacKillop, KS.44082 (AM). 1♀ NEQ, 16°04'S 145°25'E, Roaring Meg valley, 7–9 Dec 1993, 680 m, G. B. Monteith, S42583 (QM).

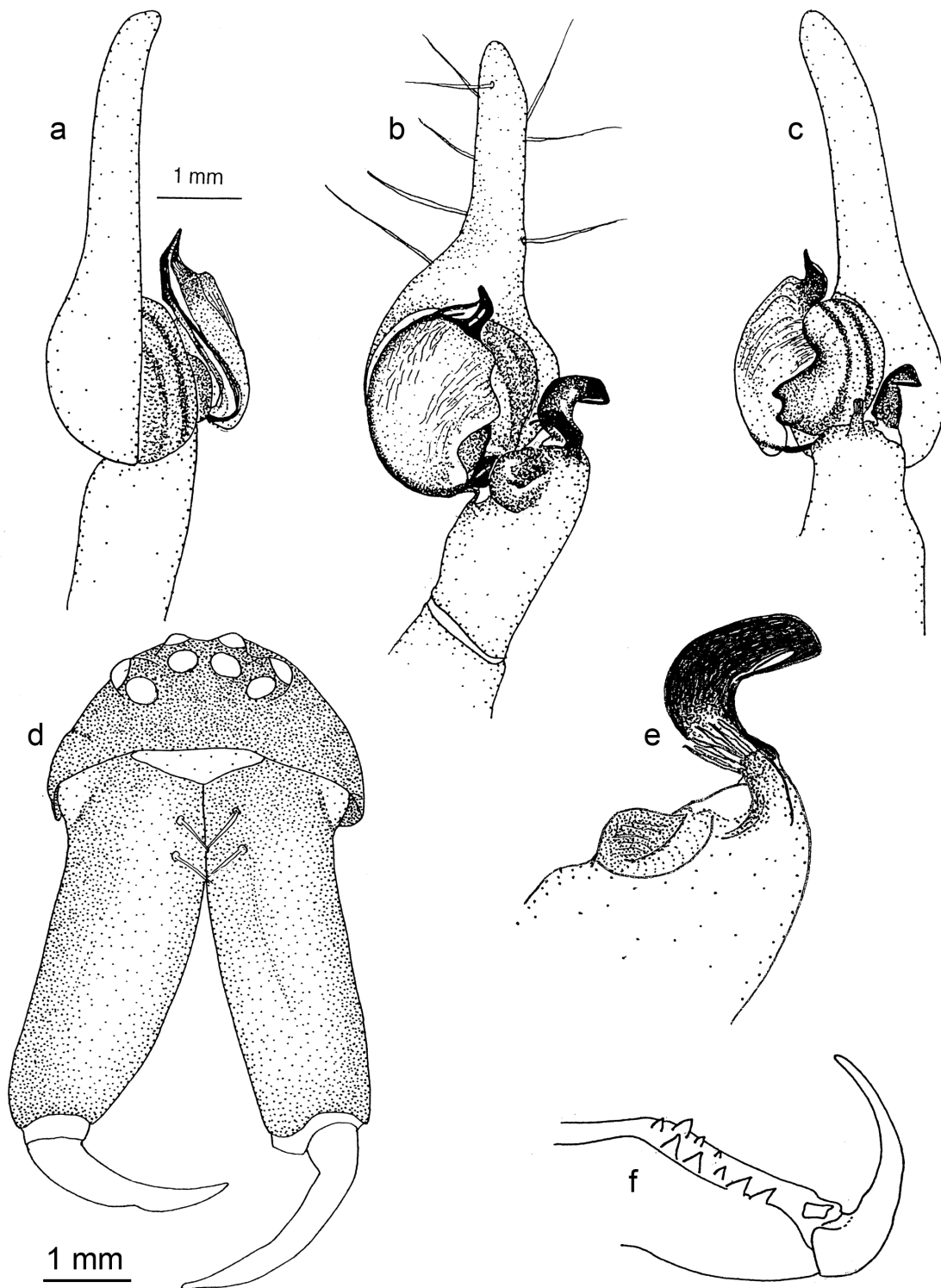

Figure 17. *Corasoides motumae* sp. nov., male: (a) palpal organs, prolateral; (b) palpal organs, ventral; (c) palpal organs, retrolateral; (d) face; (e) tibial apophyses; (f) cheliceral teeth.

Diagnosis. The male of this species can be distinguished from *C. terania* sp. nov. and species from Papua New Guinea by the presence of the bristled retroventral apophysis. It can be distinguished from both *C. motumae* sp. nov. and *C. terania* sp. nov. by its unflattened retrolateral apophysis (Fig. 20b,c,e). It can be distinguished from *C. occidentalis* sp. nov. by its relatively much shorter digitiform portion of the cymbium. Females can be distinguished by the external morphology of the epigyne.

Description. Medium to large spider. **Carapace.** Pattern similar to *C. terania* sp. nov. but less distinct (Fig. 21g). **Abdomen.** Basic dorsal pattern but with paler central stripe widening in posterior half of abdomen in holotype and some other specimens merging with the row of spots.

Male (Figs 20, 21b,d,f–h). CL 5.9 (5.2), CW 4.2 (3.8), AL 4.7, AW 3.1, HW 2.8, EpGW 1.8, MOQL 0.81, MOQAW 0.67, MOQPW 0.81, SL 2.7, SW 2.3, ML 2.1, MW 1.0,

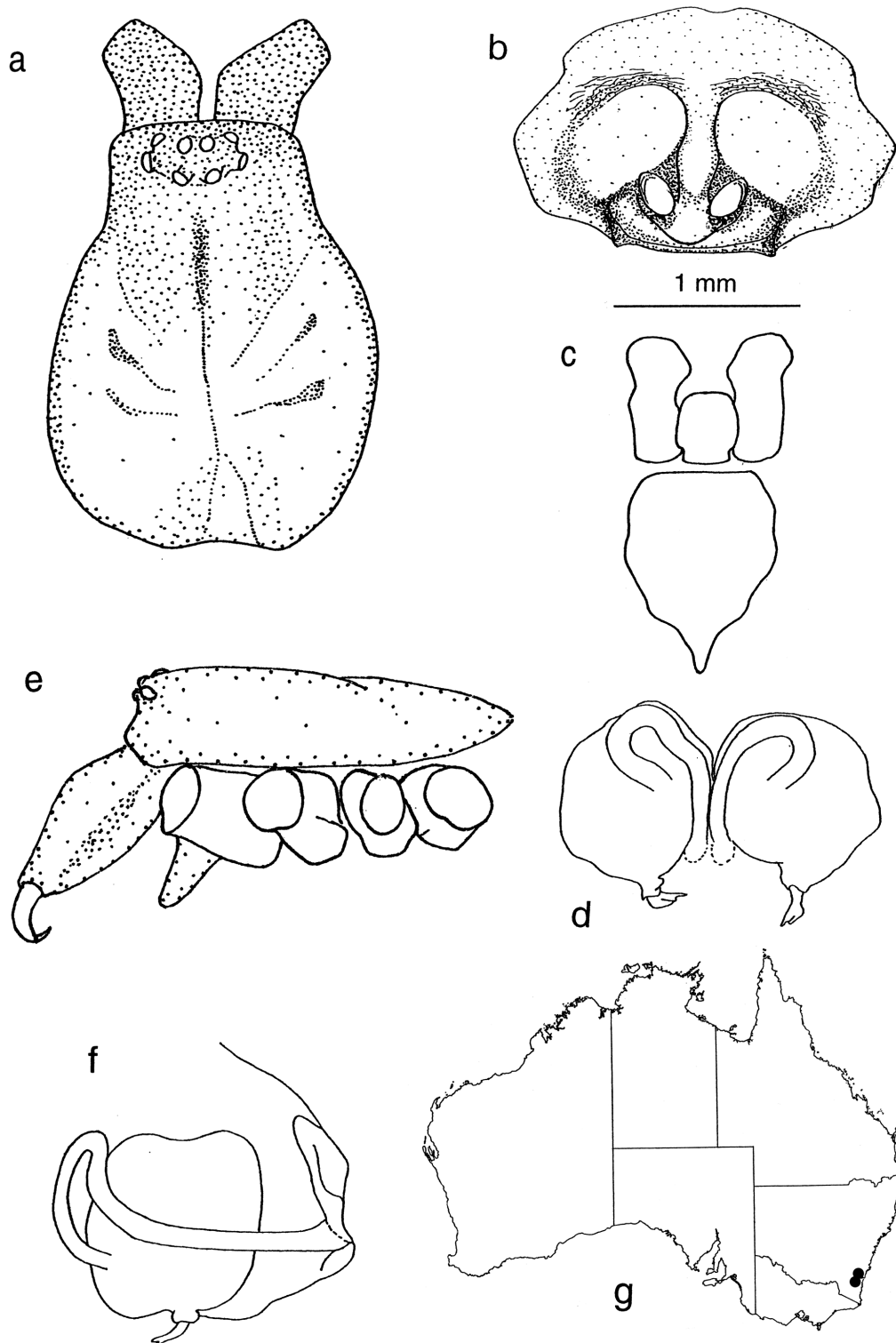

Figure 18. *Corasoides motumae* sp. nov.: (a) carapace, dorsal; (b) epigyne, ventral; (c) sternum, labium and maxillae, ventral; (d) female internal genitalia, dorsal; (e) male cephalothorax, lateral; (f) female internal genitalia, lateral from centre. (g) distribution.

LL 1.1, LW 0.8, ChelL 3.5 (3.1), ChelW 1.3 (1.1), clypeus height 0.6. **Cephalothorax.** Sternum slightly longer than wide, with a distinct, posterior point. Labium longer than wide, basally notched and slightly rebordered. **Chelicerae.** Teeth: retromarginal 5 promarginal 3 (plus one vestigial); evenly spaced and of near equal size. Transverse ridges present between teeth margins. Leg lengths:

	I	II	III	IV	Palp
femur	9.7	7.9	6.8	8.6	4.1
patella	2.1	1.9	1.8	2.0	1.1
tibia	9.8	6.6	5.1	6.4	1.6
metatarsus	9.4	8.1	7.8	10.6	—
tibia	4.1	2.4	1.8	2.8	2.6
total	35.1	26.9	18.5	30.4	9.4

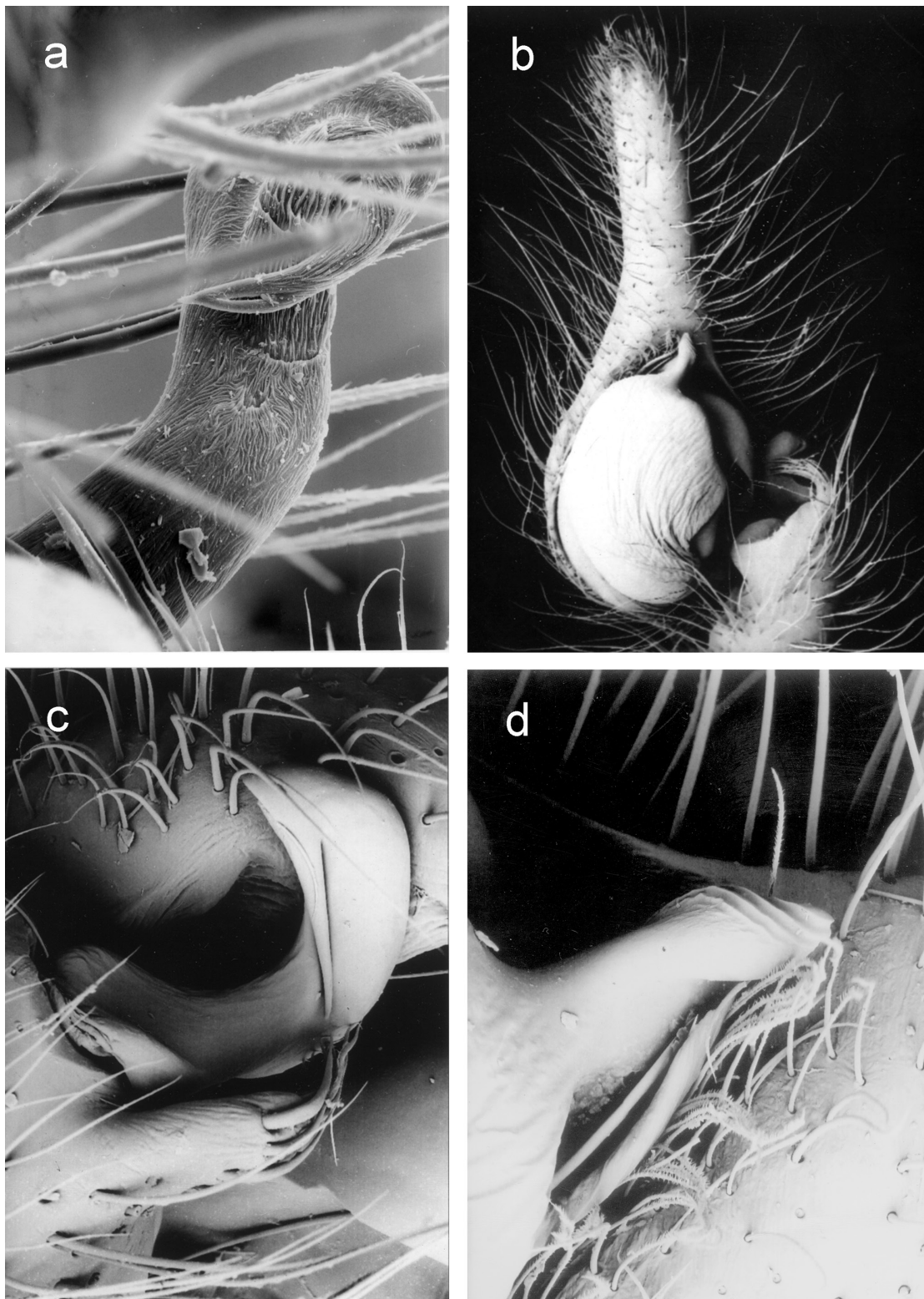

Figure 19. (a) retrolateral apophysis tip of *Corasoides occidentalis* sp. nov., Glen Forrest, WA; (b) male cymbium of *C. motumae* sp. nov., Clyde Mountain, NSW; (c) retrolateral apophysis of *C. motumae* sp. nov., Clyde Mountain, NSW; (d) conductor tip of *C. motumae* sp. nov., Clyde Mountain, NSW.

Spination. Leg I: femur d2,2,3,3,1,2,3; tibia v2,1,2,1,2; metatarsus v1,1,2,2. Leg II: femur d3,2,1,2,2,1,3,3; tibia 1,1,1 v1,1,1,2; metatarsus 2,2,2 p1,1 r1,1. Leg III: femur d3,3,2,2,3,3; tibia d1,1,1,1,1, v1,1,2; metatarsus d1,1,1,1,1,2,2 v2. Leg IV: femur d2,1,3,1,1,1,3; tibia d1,1 v2,2,2,2; metatarsus d1,1,2,1,1,1,2 v1,1,1,1,2. Palp: femur

d1,1,1,3; tibia d1,1,1,3; tarsus several. **Male palp.** Digitiform portion of cymbium moderately long—cymbium length about four times transverse diameter of bulb. Many fine, dark hairs on tibia and cymbium. Ventral apophysis partially membranous (Fig. 20e). Retrolateral apophysis long, hook-like, tapering and curving initially towards retroventral

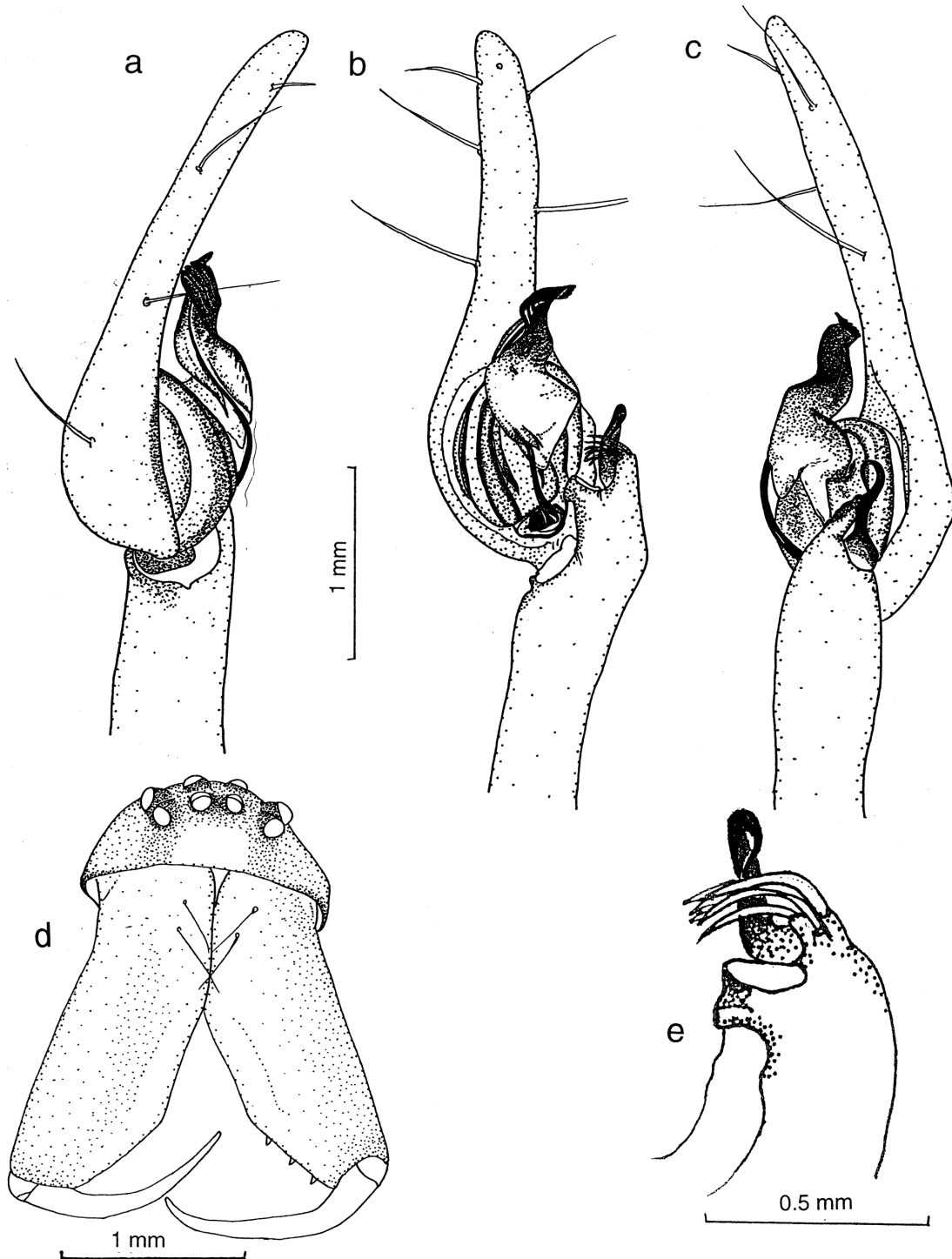

Figure 20. *Corasoides mouldsi* sp. nov., male: (a) palpal organs, prolateral; (b) palpal organs, ventral; (c) palpal organs, retrolateral; (d) face; (e) tibial apophyses.

apophysis, sweeping across slightly and finishing almost half way to its base (Fig. 20c). Embolus arises basally. Conductor stalked, wide at base. Conductor tip ridged longitudinally, bent c. 90° to point retrolaterally and twisted one full rotation (Figs 20a–c). Trichobothria on cymbium: single row of six, retrolateral to dorsal line, evenly spaced, decreasing in length basally. **Abdomen.** Tail of small spigots on anterior lateral spinnerets.

Female (Fig. 21a,c,e), similar to male. CL 7.3 (5.3), CW 4.6 (3.8), AL 10.6, AW 6.5, HW 3.8, EpGW 2.2, MOQL 0.99, MOQAW 0.85, MOQPW 1.03, SL 3.4, SW 3.0, ML

2.9, MW 1.5, LL 1.7, LW 1.3, ChelL 4.1 (2.2), ChelW 2.1 (1.4), clypeus height 0.7. **Cheliceral teeth** similar to male but unevenly spaced retromarginally. Leg lengths:

	I	II	III	IV	Palp
femur	10.1	8.8	7.8	10.5	4.5
patella	3.0	2.8	2.3	2.4	1.4
tibia	9.9	7.5	6.0	7.9	2.5
metatarsus	10.3	8.8	8.3	12.1	—
tarsus	4.3	2.8	2.8	3.4	3.1
total	37.5	30.5	27.0	36.3	11.5

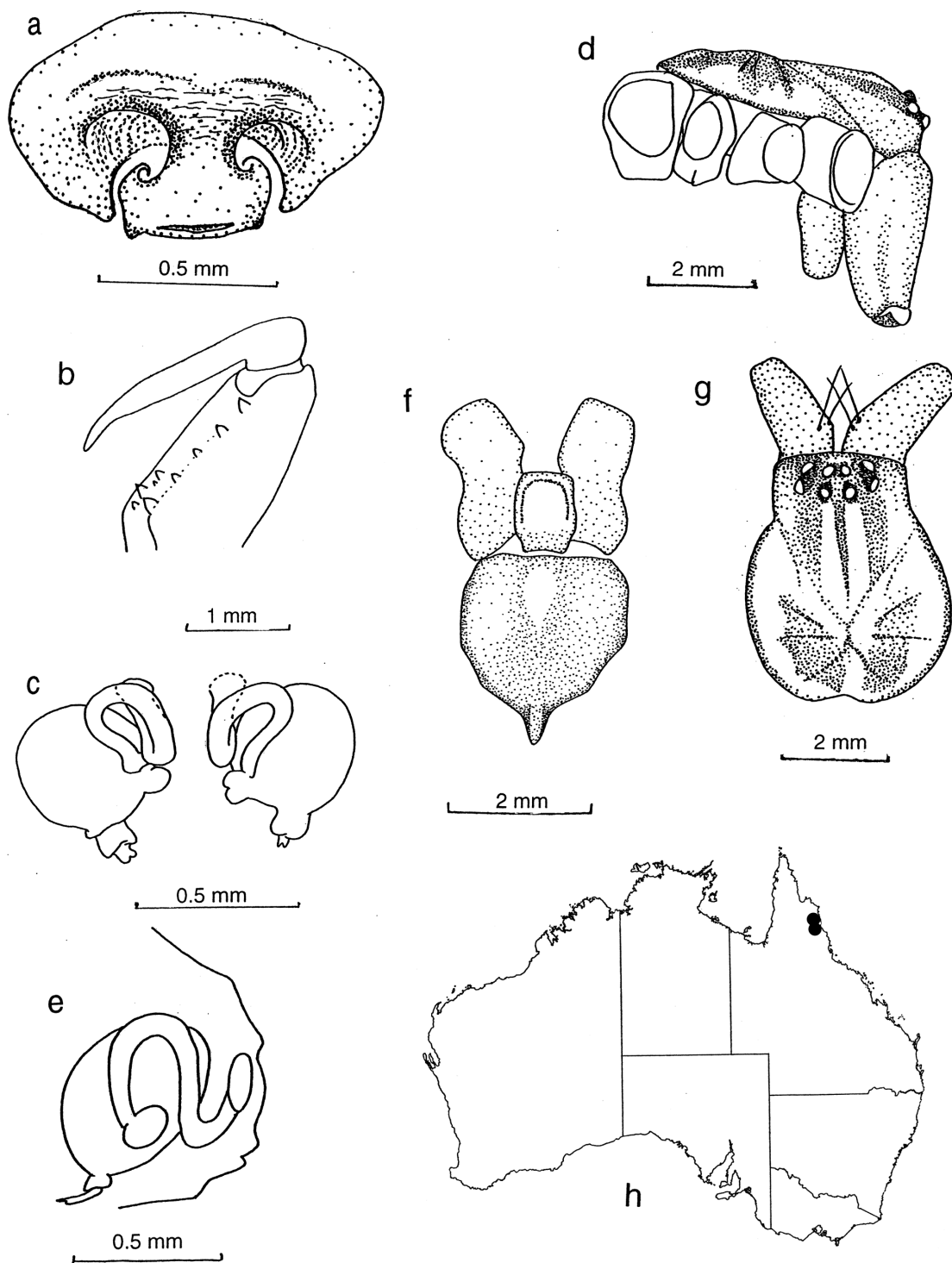

Figure 21. *Corasoides mouldsi* sp. nov.: (a) epigyne; (b) cheliceral teeth, male; (c) female internal genitalia, dorsal view; (d) lateral carapace and chelicerae, male; (e) epigyne and female internal genitalia, lateral view; (f) ventral sternum, labium and maxillae, male; (g) dorsal carapace and chelicerae.; (h) distribution.

Spination. Leg I: femur d1,3,3,3,3; tibia v2,2,2,2; metatarsus v2,2,2. Leg II: femur d3,1,3,2,3,3; tibia d1 v2,2,2,2 p1,1,1; metatarsus d1,1,1,2 v1,1,1,1,2 p1,1,1 r1,1; Leg III: femur d3,3,1,2,3,3; tibia d1 v2,2,2 p1,1,1r1; metatarsus d2,2,2,2 v2,2,2 r1,1. Leg IV: femur d1,2,3,3,3; tibia v2,2,2 p1,1,1r1,1,1; metatarsus d2,2,2,2 v2,2,2,2 p1,1,1 r1,1,1; Palp: femur d1,1,1,3; patella d1; tibia d1 p1; tarsus several. Trichobothria on 1st tarsus: single row of seven, evenly spaced, decreasing in size proximally. Tarsal organ beyond

7th trichobothrium. **Epigyne** (Fig. 21a). Width at least twice length. Smooth in profile. Long hairs directed posteriorly from anterior and sides. Genital openings near transverse midline, often plugged. Scape stalk width less than diameter of one genital atrium. Lateral extension of scape long, narrow, extending no more than midway across the genital atria. Small ridge across posterior of lateral extension. Insemination ducts arise near apex of spermathecae and initially proceed posteriorly. Ducts weakly convoluted (three

bends). Small, wide diverticula at site of entry of seminal ducts into spermathecae (Fig. 21c,e).

Habitat. Tropical rainforest. Webs are common in tree trunk crevices, epiphytes, fallen logs and other debris, favours sites of increased sunlight caused by a breaks in the tree canopy. Webs up to 2.2 m above ground level.

Distribution. Windsor Plateau and Roaring Meg valley, northeastern Queensland (Fig. 21h). Common within localized areas.

Etymology. Named after Dr Max Moulds who collected the holotype as well as many other specimens of *Corasoides*, both in Australia and in Papua New Guinea.

Corasoides nebula sp. nov.

Figs 22, 23

Holotype ♂, Ambua Lodge 25 km SE Tari, SHP, 5°58'S 143°04'E, 2100 m, PAPUA NEW GUINEA, Nov. 1996, M. Humphrey, KS.71840 (AM). **Paratypes** as follows, all Papua New Guinea: 2♂♂, 2♀♀, same data as holotype, KS.71841 (AM).

Other material examined. 5 juveniles, 4 epigynes, same data as holotype (AM).

Diagnosis. CL less than 3.0 mm. Male with enlarged anterior, retrolateral cheliceral teeth (Fig. 23b). Retrolateral apophysis with fine spine-like apex (Fig. 22a,b). Can be distinguished from the closely related *C. cowanae* sp. nov. by the absence of a dorsal tibial process on the male palp, by the wide scape in the female and highly convoluted but uncoiled insemination ducts (Fig. 23d,e,f).

Description. Small spider. **Carapace.** Light cream with faint grey pattern. Other specimens with darker grey pattern. Edged with dark grey except in petiole region. **Abdomen.** In holotype dark; central grey stripe and spots indiscernible. Dorsolateral stripes to anterior half of abdomen but thin. In other specimens spots are discernible and dorsolateral stripes wider but shorter.

Male (Figs 22, 23a,b,g). CL 2.4 (2.6), CW 1.9 (1.8), AL 1.8, AW 1.2, HW 1.2, EpGW 0.9, MOQL 0.48, MOQAW 0.34, MOQPW 0.44, SL 1.2, SW 1.2, ML 0.9, MW 0.5, LL 0.5, LW 0.4, ChelL 1.7 (1.9), ChelW 0.6 (0.8), clypeus height 0.2. **Cephalothorax.** Sternum equal in width and length, posterior point blunt. Labium width and length roughly equal, notched basally. **Chelicerae.** Long. Boss insignificant. Cheliceral teeth: retromarginal 6–8, anterior tooth greatly enlarged; promarginal 4. No transverse ridges between teeth margins. Fangs wide, robust, angular, without serrations. Dark banding on legs. Leg lengths:

	I	II	III	IV	Palp
femur	5.4		3.9	5.0	1.6
patella	1.0		0.8	1.0	0.5
tibia	5.1		2.6	4.1	0.5
metatarsus	5.7		4.0	6.2	—
tarsus	3.0		1.8	2.5	2.1
total	20.1		13.1	18.8	3.1

Spination (on leg II from paratype). Leg I: femur d1,1,1,2; tibia v1,1,1,2; metatarsus v2,2,2,2. (Leg II: femur d113; tibia

v112; metatarsus v112). Leg III: femur d1,2,1,2,1,2,1,2; patella d1; tibia d1,2,2,2 r1; metatarsus d1,1,1,1,1,2 v1,1,1,1,2. Leg IV: femur d1,1,2,1,1,2; tibia 1,1,1,1,1 pl r1,1; metatarsus d1,2,2,2,2,1,2 v1,2,2,2,2,2; Palp: femur d1,1,3; patella d1,1; tarsus several. **Male palp.** Digitiform portion of cymbium moderately long, cymbium length approximately three times diameter of bulb. Retroventral apophysis absent. Ventral apophysis erect, curled on lateral edge, not enclosing any intersegmental membrane. Retrolateral apophysis robust, with curved basal portion, spine-like portion fine, curved, pointing away from bulb retrolaterally. Trichobothria on cymbium indistinct, 2–5. **Abdomen.** No tail of small spigots on anterior lateral spinnerets.

Female (Fig. 23c–g), similar to male. CL 2.4 (2.1), CW 1.8 (1.6), AL 2.4, AW 1.6, HW 1.0, EpGW 0.7, MOQL 0.4, MOQAW 0.3, MOQPW 0.4, SL 1.1, SW 1.2, ML 0.8, MW 0.4, LL 0.4, LW 0.4, ChelL 1.6 (1.2), ChelW 0.7 (0.6), clypeus height 0.5. **Chelicerae.** Boss small. Cheliceral teeth 8(7), 2(4), without enlargements as in male. Legs darkly banded. Leg lengths:

	I	II	III	IV	Palp
femur	3.8	2.8	2.4	3.5	1.2
patella	0.8	0.7	0.7	0.7	0.4
tibia	3.7	2.2	2.5	2.8	0.8
metatarsus	3.5	2.4	2.5	3.7	—
tarsus	2.1	1.4	1.5	1.6	1.3
total	13.8	9.6	9.6	12.3	3.6

Spination. Leg I: femur d1,1,2; tibia d1; metatarsus v2. Leg II: femur d1,1,1,3; tibia d1 v1,2; metatarsus v1,2. Leg III: femur d1,1,1,3; patella d1; tibia d1,1,1, v2; metatarsus d2,2,2,2 v1,2 r1. Leg IV: femur d1,1,1,1,1,1,4; patella d1; tibia d1,1,1,3,2 v2 r1,1; metatarsus d2,2,2,2 v1,2. Palp: femur d1,1; patella d1,1; tibia d1,1; tarsus several. Trichobothria on 1st tarsus: single row of 5, decreasing in length proximally. **Epigyne** (Fig. 23c). Wider than long. Smooth, with beak projecting posteriorly over anterior of scape stalk. Scape stalk wide, approximately equal to diameter of one genital atrium. Genital atria and openings situated in posterior half of epigyne. Lateral margin of lateral extensions of scape indiscernible. Insemination ducts strongly convoluted but with no coils (c. 9 bends) (Fig. 23e,f). Spermathecae well separated (Fig. 23d).

Habitat. Tropical rainforest, 2100 m. Webs were common projecting from damp earthen slopes and embankments where retreats were sited in crevices or amongst leaf litter.

Distribution. Known only from holotype locality, 25 km south east of Tari, Papua New Guinea (Fig. 23g).

Etymology. From the Latin *nebula*, meaning mist or fog and referring to the mist forest inhabited by this species.

Corasoides nimbus sp. nov.

Figs 24, 25

Holotype ♂, Mt. Giluwe 2500 m, [6°10'S 143°50'E], 7.vi.63, Sedlacek, NEW GUINEA SE [Papua New Guinea] (BPBM). **Paratypes** as follows, all Papua New Guinea: 3♀♀, data as for holotype (BPBM); 3♀♀, Mt Wilhelm, 3000 m, [5°47'S 145°0'E], VII.4.1955, NEW GUINEA NE. (BPBM).

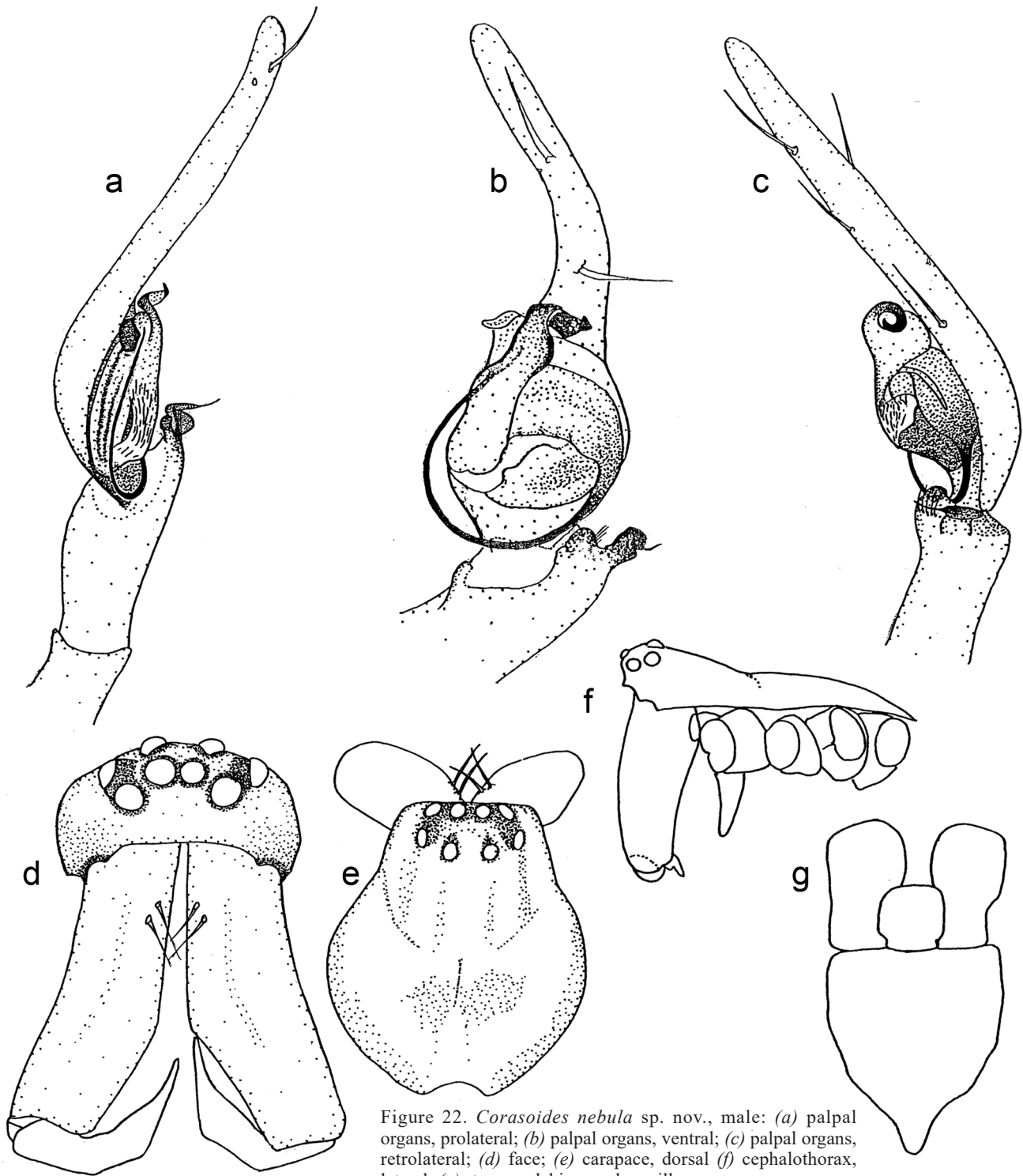

Figure 22. *Corasoides nebula* sp. nov., male: (a) palpal organs, prolateral; (b) palpal organs, ventral; (c) palpal organs, retrolateral; (d) face; (e) carapace, dorsal (f) cephalothorax, lateral; (g) sternum, labium and maxillae.

Other material examined all Papua New Guinea. 4 penultimate ♀♀, 2 juveniles, Mt Wilhelm, 3000 m, [5°47'S 145°0'E], VII.4.1955, NEW GUINEA NE. (BPBM).

Diagnosis. The males of only *C. nimbus* sp. nov. and *C. cowanae* sp. nov. possess a simple, sclerotized retrodorsal tibial apophysis. The males of *C. nimbus* sp. nov. also differ from the males of *C. angusi* sp. nov. in having a bluntly pointed retrolateral apophysis bent towards the bulb rather than hooked. In addition, the tip of the conductor is ridged, and is not pointed. Females can be distinguished from *C.*

stellaris sp. nov. and *C. angusi* sp. nov. by the number and configuration of the insemination ducts (Fig. 25f–h). Female *C. nimbus* sp. nov. cannot be distinguished externally from *C. angusi* sp. nov., *Corasoides nimbus* sp. nov. or *C. angusi* sp. nov. *Corasoides* can be distinguished from *C. stellaris* sp. nov. by the lateral extension of their scapes, which are no wider than half the width of the epigyne.

Description. Medium to large spider. **Carapace.** Basic pattern barely discernible in alcohol specimens. **Abdomen.** Basic pattern barely discernible in alcohol specimens.

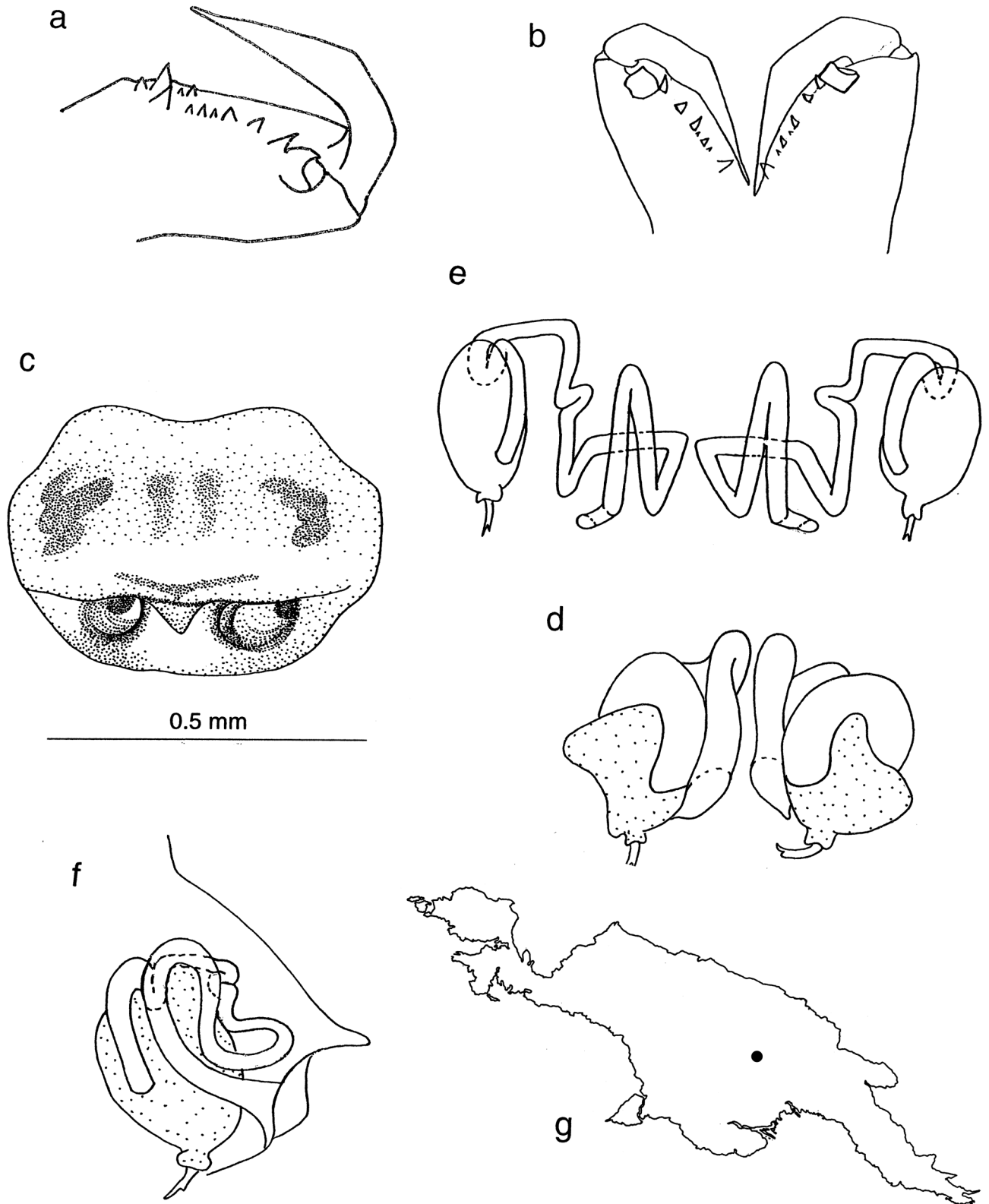

Figure 23. *Corasoides nebula* sp. nov.: (a) cheliceral teeth; (b) chelicerae, ventral; (c) epigyne, ventral; (d) female internal genitalia, dorsal; (e) female internal genitalia, dorsal exploded view; (f) female genitalia, lateral, from centre; (g) distribution.

Male (Figs 24, 25a–d,i). CL 4.3, CW 3.7, AL 4.8, AW 3.3, HW 2.4, EpGW 1.5, MOQL 0.73, MOQAW 0.58, MOQAP 0.70, SL 2.1, SW 2.4, ML 2.0, MW 0.9, LL 0.9, LW 0.9, ChelL 3.5, ChelW 1.1, clypeus height 0.5. **Cephalothorax.**

Sternum; length roughly equal to width, moderate posterior point Labium longer than wide, with basal notch (Fig 25c). **Cheliceral teeth.** retromarginal 5(6), promarginal 4, unequal size, no fusions. No ridges between teeth margins. Leg lengths:

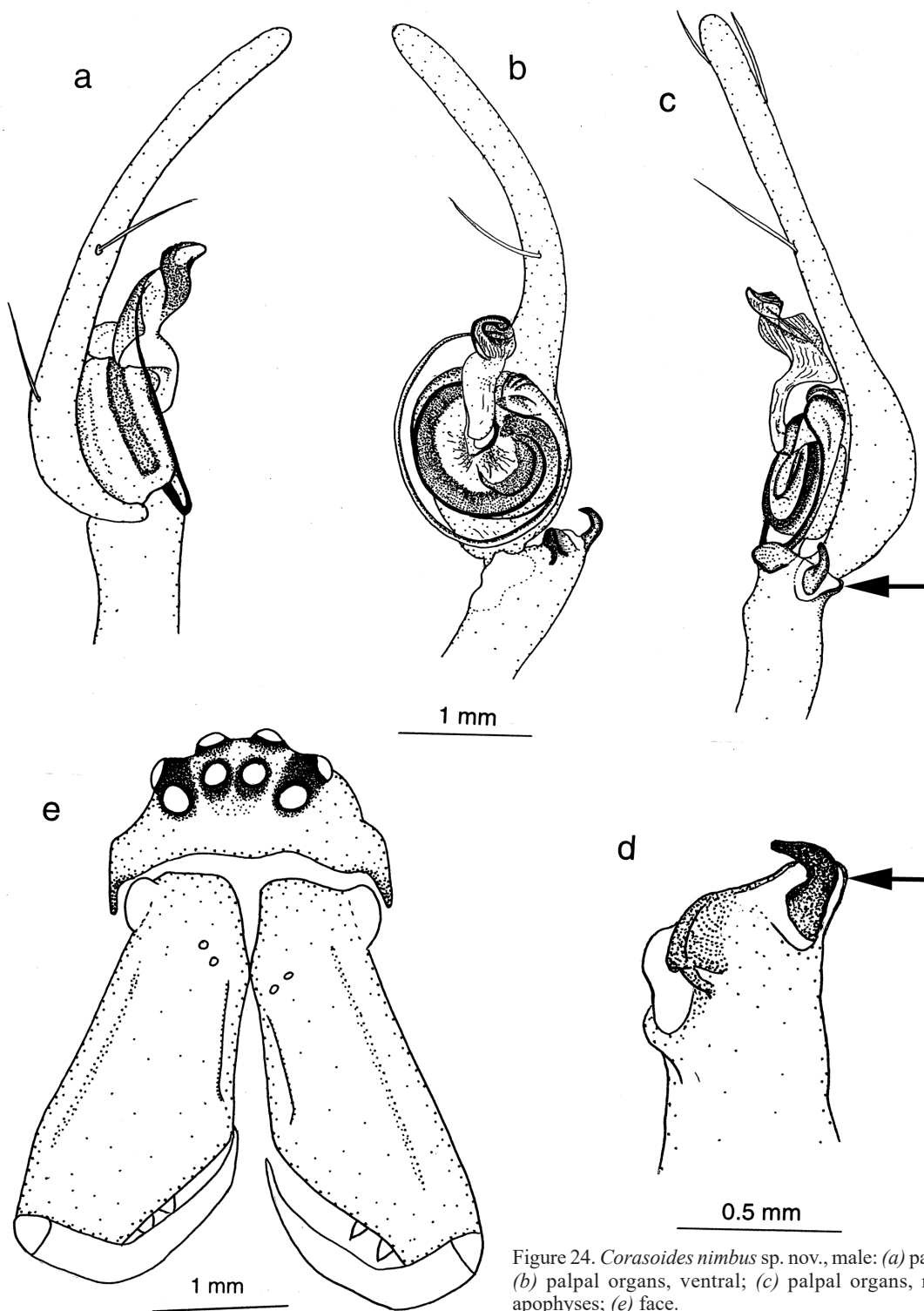

Figure 24. *Corasoides nimbus* sp. nov., male: (a) palpal organs, prolateral; (b) palpal organs, ventral; (c) palpal organs, retrolateral; (d) tibial apophyses; (e) face.

	I	II	II	IV	Palp
femur	8.9	7.4	5.9	8.4	3.6
patella	2.0	1.9	1.4	1.8	0.9
tibia	8.9	6.1	4.3	6.8	1.5
metatarsus	8.9	6.6	6.1	8.8	—
tarsus	4.4	3.0	2.6	3.6	3.3
total	33.0	25.0	20.3	29.3	18.8

Spination. Leg I: femur d1,3,1,4,2,3; tibia v2,1,1,1,1,1,2,2; metatarsus d1,1 v2,2,2,2. Leg II: femur d1,3,3,3; tibia

v2,2,2,2; metatarsus v2,2,2,2. Leg III: femur d1,2,2,2 p1; tibia d1,1,1,1,1,1 v1,1,1,2 r1,1; metatarsus d2,2,2,2 v2,2,2,2. Leg IV: femur d1,2,2,2 p1; tibia v1,2,1; metatarsus d1,1,1,1,1,1,1,1 v1,1,1,1,2; palp: femur d1,1,3; tibia v1; tarsus several. **Male palp.** Digitiform portion of the cymbium long—three times the diameter of the bulb. Retroventral apophysis absent. Ventral apophysis low, lobe-like and not enclosing any area of intersegmental membrane. Retrolateral apophysis simple, moderately robust, tapering but bluntly pointed and curved towards the bulb (Fig. 24d). Embolus

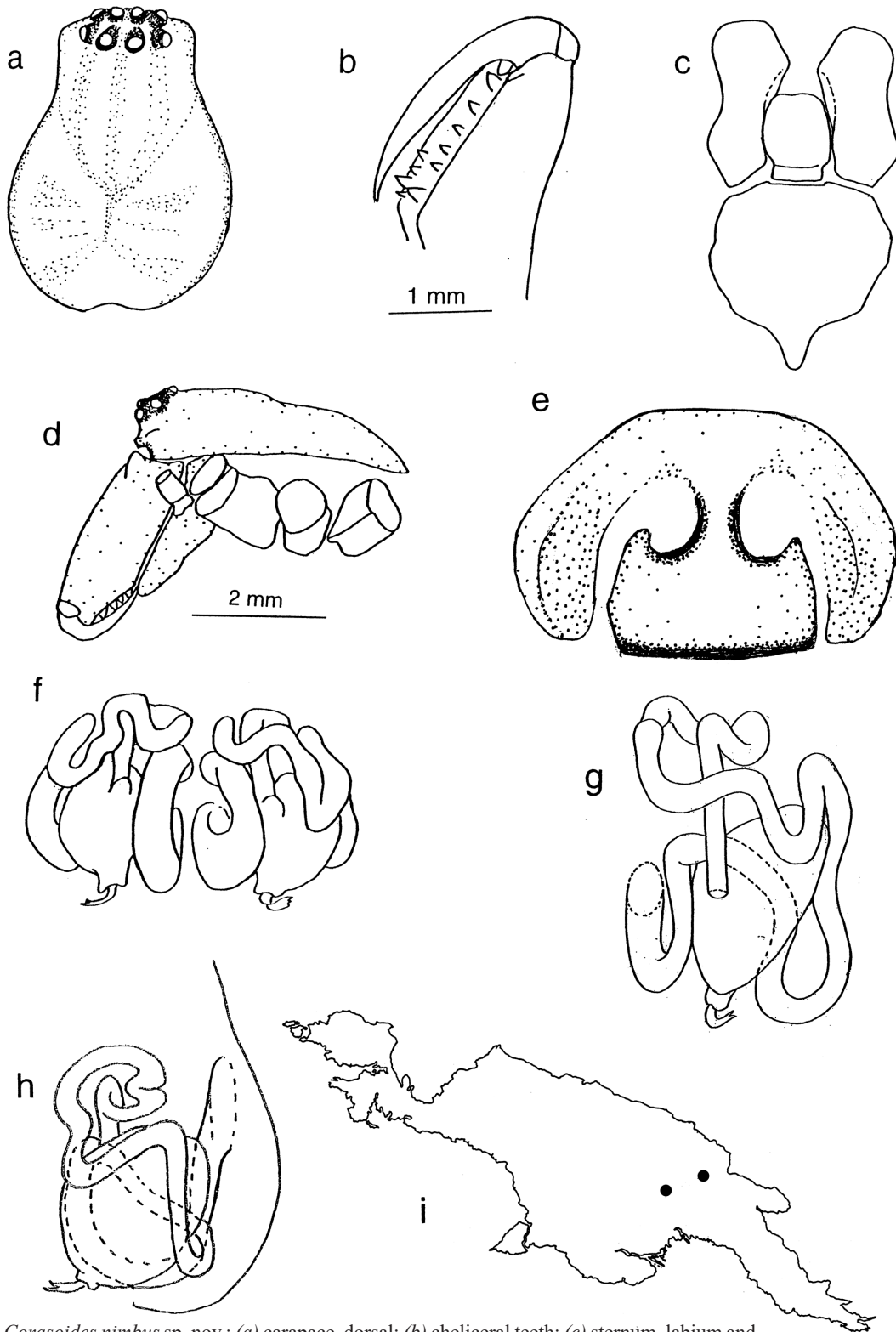

Figure 25. *Corasoides nimbus* sp. nov.: (a) carapace, dorsal; (b) cheliceral teeth; (c) sternum, labium and maxillae; (d) cephalothorax, lateral; (e) epigyne; (f) female internal genitalia; (g) female internal genitalia, exploded view; (h) female genitalia, right lateral.; (i) distribution. Arrows indicate ventral apophysis.

long, curved, arises on the retrolateral margin, enters conductor prolaterally. Conductor stalked, with narrow base. Sclerotized tip of conductor ridged, twists full rotation to point away from bulb (Fig. 24a–c). Three trichobothria on cymbium. **Abdomen.** Anterior lateral spinnerets with tail of small spigots.

Female (Fig. 25e–i), similar to male. CL 6.9 (6.6), CW 5.3 (4.8), AL 10.0, AW 7.9, HW 3.4, EpGW 1.8, MOQL 0.97, MOQAM 0.72, MOQPA 0.91, SL 3.4, SW 2.8, ML 2.5, MW 1.2, LL 1.4, LW 1.2, Chel L 4.4 (3.6), ChelL 1.5 (1.4), clypeus height 0.6. **Chelicerae** slightly bent, cheliceral teeth: retromarginal 6, promarginal 3. Leg lengths:

	I	II	III	IV	Palp
femur	9.4	7.6	6.6	8.4	4.0
patella	2.5	1.8	1.8	2.3	1.3
tibia	9.8	6.9	4.6	7.3	2.5
metatarsus	9.5	7.1	7.6	10.3	—
tarsus	4.1	3.4	2.8	2.8	3.4
total	35.3	26.8	23.4	30.8	11.2

Spination. Leg I: femur d1,1,1,1,1 p1,1,1,1,1,1 r1,1,1,1,1,1; tibia v1,2,2,1,1; metatarsus v2,2,2,2. Leg II: femur d1,1,1,1,1 p1,1,1,1,1,1 r1,1,1,1,1,1; tibia v 2,1,1,1,2,1,2; metatarsus v2,2,2,2. Leg III: femur d3,3,3,3,3; tibia d1 v2,1,2,2 p2; metatarsus v2,2,2,2 p2. Leg IV: femur d1,1,1,1,1,2 p1,1,1; tibia d1 v1,1,1,2 p1 r1; metatarsus v2,2,2,2 p2; palp: femur d1,1,1,3, patella d1 tibia d1,1; tarsus several. Trichobothria on 1st tarsus: 6, evenly spaced, decreasing in length proximally. **Epigyne** (Fig. 25e). Similar to *C. angusi* sp. nov. and *C. stellaris* sp. nov. Length 0.69, width 1.25, Smooth. Genital openings near transverse midline. Scape stalk short, slightly narrower than diameter of genital opening. Lateral extensions of scape wide, greater than diameter of genital openings and extending almost to lateral margin of genital openings. Anterior and lateral surfaces of epigyne covered in long, posteriorly directed hairs. Genital openings arising on transverse midline. Insemination ducts highly convoluted, with at least eight bends. Very small diverticula at site of entry into spermathecae (Fig. 25f–h).

Remarks. The material examined from Mt Wilhelm differs only superficially in the female internal genitalia from specimens of *C. nimbus* sp. nov. from Mt Giluwe and is otherwise indistinguishable from them. No male was available from Mt Wilhelm and it is possible that it may prove to be a separate species. However, the females of *C. angusi* sp. nov. and *C. nimbus* sp. nov. appear identical externally and *C. stellaris* sp. nov. almost so, yet the internal genitalia are all different. For this reason, I have included specimens from Mt Wilhelm in *C. nimbus* sp. nov.

Habitat. Unknown, but presumed from the collection site localities to be mist forest.

Distribution. Mt Giluwe (2500 m), Southern Highlands Province and Mt Wilhelm (3000 m), Chimbu Province, Papua New Guinea (Fig. 25i).

Etymology. From the Latin *nimbus* (masculine) meaning a rain cloud and referring to the misty, high altitude where the types were collected.

Corasoides occidentalis sp. nov.

Figs 19a, 26–29

Holotype ♂, Yallingup, Western Australia, 33°42'S 115°02'E, 02 Oct. 1993, M. Humphrey, KS.71658 (AM). **Paratypes** as follows, all Western Australia: 6♂♂, Yallingup, 33°42'S 115°02'E, 02 Oct. 1993, M. Humphrey, KS.71674 (AM); 1♂, Yallingup, 33°42'S 115°02'E, 02 Oct. 1993, M. Humphrey; 1♂, 2♀♀, Yallingup, 33°42'S 115°02'E, 02 Oct. 1993, M. Humphrey, KS.71670 (AM); 1♂, Cervantes, 30°30'S 115°04'E, 06 Oct. 1993, M. Moulds, KS.71675; 1♂, 1♀, Nannup, 33°59'S 115°45'E, 02 Oct. 1993, MM, KS.71672; 1♂, 1♀, Fitzgerald River NP, 33°55'S 120°10'E, 29 Sept. 1993, M. Humphrey, KS.71673; 1♂, Jewel Cave, 34°05'S 115°06'E, 02 Oct. 1993, M. Humphrey, KS.71681; 2♂♂, Kalbarri NP, 27°40'S 114°22'E, 09 Oct. 1993, M. Humphrey, KS.71679; 3♂♂, 2♀♀, Stokes River NP, 33°50'S 121°08'E, 13 Oct. 1993, M. Humphrey, KS.71678; 1♂, 1♀, Stirling Ranges NP, 34°22'S 118°08'E, 30 Sept. 1993, M. Humphrey, KS.71676;

3♂♂ 2♀♀, Corrigin, 32°20'S 117°52'E, 10 Oct. 1993, M. Humphrey, KS.71677; 2♀♀, Gelorup, 33°23'S 115°39'E, 03 Oct. 1993, M. Humphrey, KS.71680; 3♂♂, Gelorup, 33°23'S 115°39'E, 03 Oct. 1993, M. Humphrey, KS.71671 and KS.71684; 1♂, Glen Forrest, 31°55'S 116°04'E Oct. 1993, M. Humphrey, KS.71682; 1♂, Toodyay, 31°33'S 116°28'E, 04 Oct. 1993, M. Humphrey, KS.1683 (AM). 1♂, Cannington Bot Res., 32°01'S 115°58'E, Dec. 1986, W. Humphreys *et al.*, 92/31; 1♀, Gordon River at Albany H-way crossing, 34°17'S 117°30'E, 10 Nov. 1990, A. F. Longbottom 19/40; 1♂, Gelorup Rise (lot 101), 33°45'S 115°38'E, 14 Oct. 1991, K. Longbottom; 1♂, Bold Park, 31°57'S 115°46'E, 20 Dec. 1988, Jiang Wang Gao 92/26; 1♂, 6.5 km NW of Meelup, 33°33'30"S 115°01'00"E, 25 Oct. 1985, G. A. Harold, 92/47; 1♀, Bold Park, 31°57'07"S 115°45'30"E, 15 Mar 1987, W. Humphreys *et al.*, 92/24; 1♀, 15 km E of Mount Barker, 34°40'S 117°31'E, 22 Feb. 1990, M. S. Harvey & M. E. Blossfelds, 92/49; 1♂, Jandakot, 32°06'S 115°52'E, 31 Dec. 1981, S. R. Robinson, 92/16; 1♂, Naval Base, 32°12'S 115°47'E, 19 Dec. 1971, E. L. Joll, 92/18; 1♂, 9.6 km E of Green Head, 30°04'S 114°58'E, Dec 1971, (no collector), 19/13; 1♀, Kallarup, 31°47'28"S 115°44'28"E, T. C. Connolly, 92/14; 1♀, Cape Naturaliste, 33°32'S 115°00'E, 12 Nov. 1979, G. B. Muir, 92/2; 1♂, Albany (37 Parker St), 35°00'S 117°53'E, ... Apr. 1964, A. Twaddle, 92/1; 1♂, Stirling Range NP 6.8 km S of Bull Knoll, 34°29'S 118°15'E, 18 Oct. 1989, G. Friend, G. Hall & D. Mitchell, 92/23; 1♂, Glen Forrest, 31°55'S 116°06'E, 09 Dec. 1974, E. Postmus, 92/11; 1♂, 1♀, Chesapeake Rd & Gardener Rd junction, 34°46'S 116°10'E, 01 May 1990, M. S. Harvey & J. M. Waldock, 92/34-35; 1♂, Parmelia, 32°15'S 115°47'E, 27 Dec. 1989, A. E. de Jong, 92/19; 1♂, Gelorup Rise, 33°23'S 115°38'E, 11 Dec. 1990, K. Longbottom, 92/3; 1♀, Mt Cooke, 32°25'S 116°18'E, 17 Feb. 1991, M. S. Harvey, 92/53; 1♂, Perth Airport, 31°55'24"S 115°58'40"E, Dec. 1986, W. Humphreys *et al.*, 92/58; 1♂, 6 km at 15° from Mullaaloo Beach, 31°47'S 115°44'E, 10 Sept. 1978, A. Chapman & R. How, 85/13; male, Salter's Point, 31 Oct. 1987, M. Koch, 88/49; 1♂, Augusta, 1.5 km NE of, 34°18'15"S 115°10'15"E, 30 Nov. 1985, G. A. Harold, 92/21 (WAM).

Other material examined all Western Australia. 2 juv., Cape le Grande, 34°00'S 122°00'E, 01 Sept. 1993, M. Humphrey; 1♂, palps of another male, 2♀♀, Glen Forrest, 31°55'S 116°06'E, 04 Oct. 1993, M. Humphrey, KS.71685; 2 juv., Toodyay, 31°33'S 116°28'E, 04 Oct. 1993, M. Humphrey; 3♀♀, Yallingup, 33°42'S 115°02'E, 02 Oct. 1993, M. Humphrey; 3♂♂ and pair male palps, Gelorup, 33°23'S 115°39'E, 03 Oct. 1993, M. Humphrey; 4 juv., Kalbarri NP, 27°40'S 114°22'E, 09 Oct. 1993, M. Humphrey; 1♀ abdomen, 3 juv., Corrigin, 32°20'S 117°52'E, 10 Oct. 1993, M. Humphrey; 3 juv, pair male palps, Jewel Cave, 34°05'S 115°06'E, 02 Oct. 1993, M. Humphrey; 3 juv, Stirling Ranges NP, 34°22'S 118°08'E, 30 Sept. 1993, M. Humphrey; 1 juv, Stokes River NP, 32°35'S 134°08'E, 13 Oct. 1993, M. Humphrey; 1 juv., Fitzgerald River NP, 34°05'S 120°35'E, 29 Sept. 1993, M. Humphrey (AM). 1♀, E King River, 34°45'6"S 117°55'9"E, D. Hirst, ARA5322 DH2536 (SAM). 1♂, Gelorup Rise, 33°23'12"S 115°38'43"E, 25 Nov. 1990, A. F. Longbottom, 19/10; 1♀, Cervantes, 30°30'S 115°04'E, 14 Jan. 1977, K. Zwanenburg, 19/33; 1♂, Cannington Bot Res, 32°01'29"S 115°58'57"E, 27 Jan. 1987, W. Humphreys *et al.*, 92/32; 1♀, Chinocup Reserve 6.4 km E of Pingrup, 33°32'S 118°24'E, 14 Feb. 1972, W. H. Butler, 92/36; 1♂, Gelorup, 33°23'12"S 115°38'43"E, 25 Nov. 1990, A. F. Longbottom, 19/10 (WAM).

Diagnosis. The male can be distinguished from other Australian species by the very long cymbium, which is up to six times as long as the diameter of the bulb and also by the presence on the conductor tip of a flange which sweeps around it about 180° (Figs 26a–c,e,f, 28a–d). The female can be distinguished by the lateral profile of the epigyne in which the scape protrudes at almost 90° (Fig. 27g).

Description. Medium to large spider. **Carapace.** Light tan. Dark tan on chelicerae and head region, extending posteriorly to fovea and then diverging to either side of petiole area. Dark brown edging to carapace except in petiole region. **Abdominal pattern.** Similar to basic pattern but with central stripe wide and almost merging with row of spots.

Male (Figs 19a, 26, 27a–d,f, 28, 29). CL 6.7 (3.1–6.8), CW 5.3 (2.5–5.3), AL 6.0, AW 4.0, HW 2.9, EpGW 1.8, MOQL 0.73, MOQAW 0.61, MOQPW 0.70, SL 3.5, SW 2.7, ML 2.9, MW 2.4, LL 1.5, LW 1.2, ChelL 5.6 (3.0–5.8), ChelW 1.9 (1.1–1.9), clypeus height 0.85 (1.3), clypeus concave.

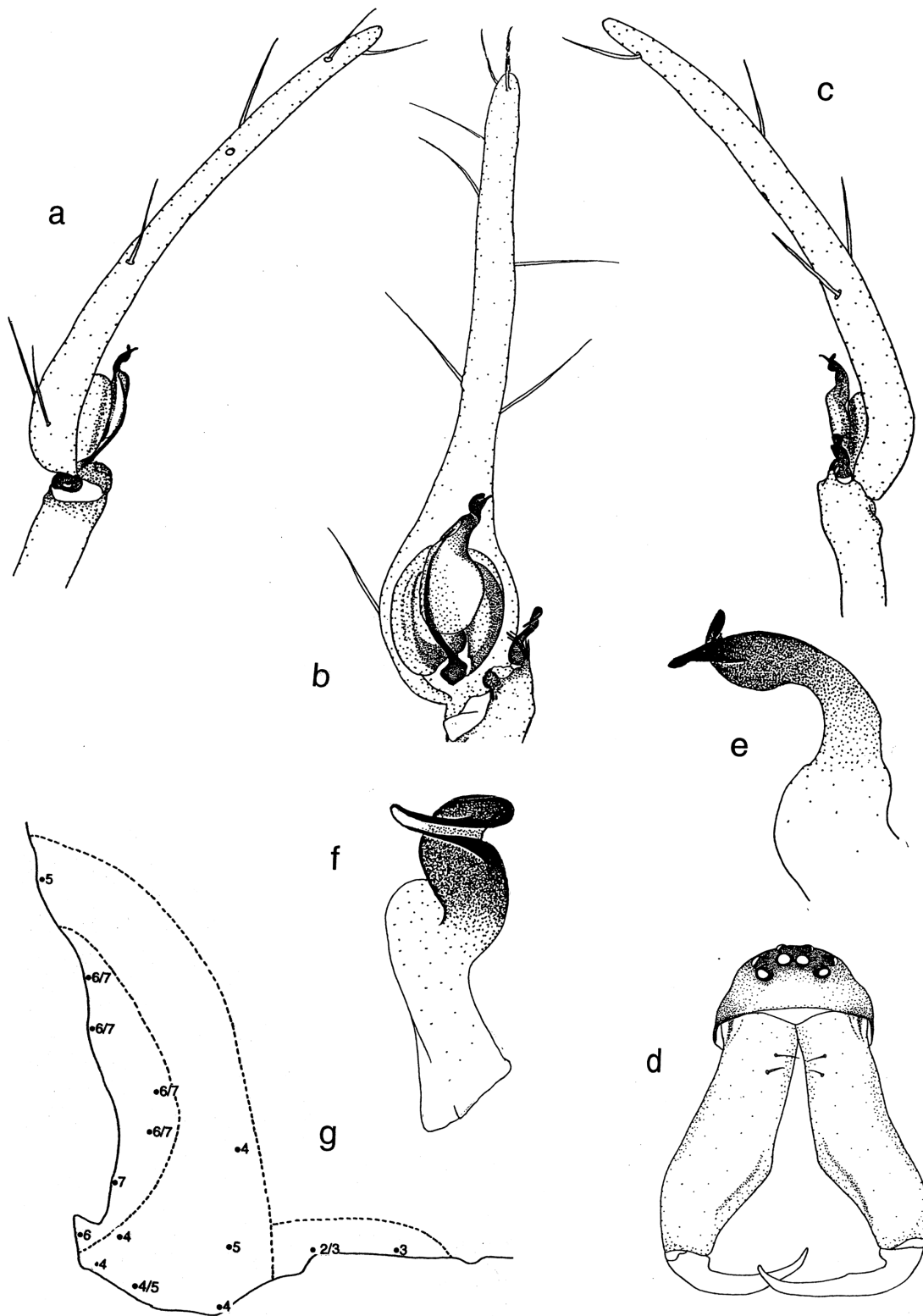

Figure 26. *Corasoides occidentalis* sp. nov., male: (a) palpal organs, prolateral; (b) palpal organs, ventral; (c) palpal organs, retrolateral; (d) face; (e) conductor tip, retrolateral/dorsal view; (f) conductor tip, retrolateral view; (g) distribution of number of trichobothria present on cymbium.

Cephalothorax. Sternum longer than wide, moderate point posteriorly. Labium longer than wide, basally notched. **Chelicerae.** Prominent pair of cheliceral bristles reduced, not crossing in front. Cheliceral teeth: retromarginal 5, promarginal 3 plus one undersized; evenly spaced and of near equal size. Transverse ridges present between teeth margins. Fangs slightly shorter than other *Corasoides* and with serrations. Leg lengths:

	I	II	III	IV	Palp
femur	9.4	7.9	6.4	9.1	5.7
patella	2.3	2.3	1.9	2.0	1.4
tibia	9.5	7.4	5.1	7.5	1.0
metatarsus	10.0	7.9	7.5	10.8	—
tarsus	3.6	2.8	2.1	2.9	6.4
total	34.8	28.1	23.0	32.5	14.5

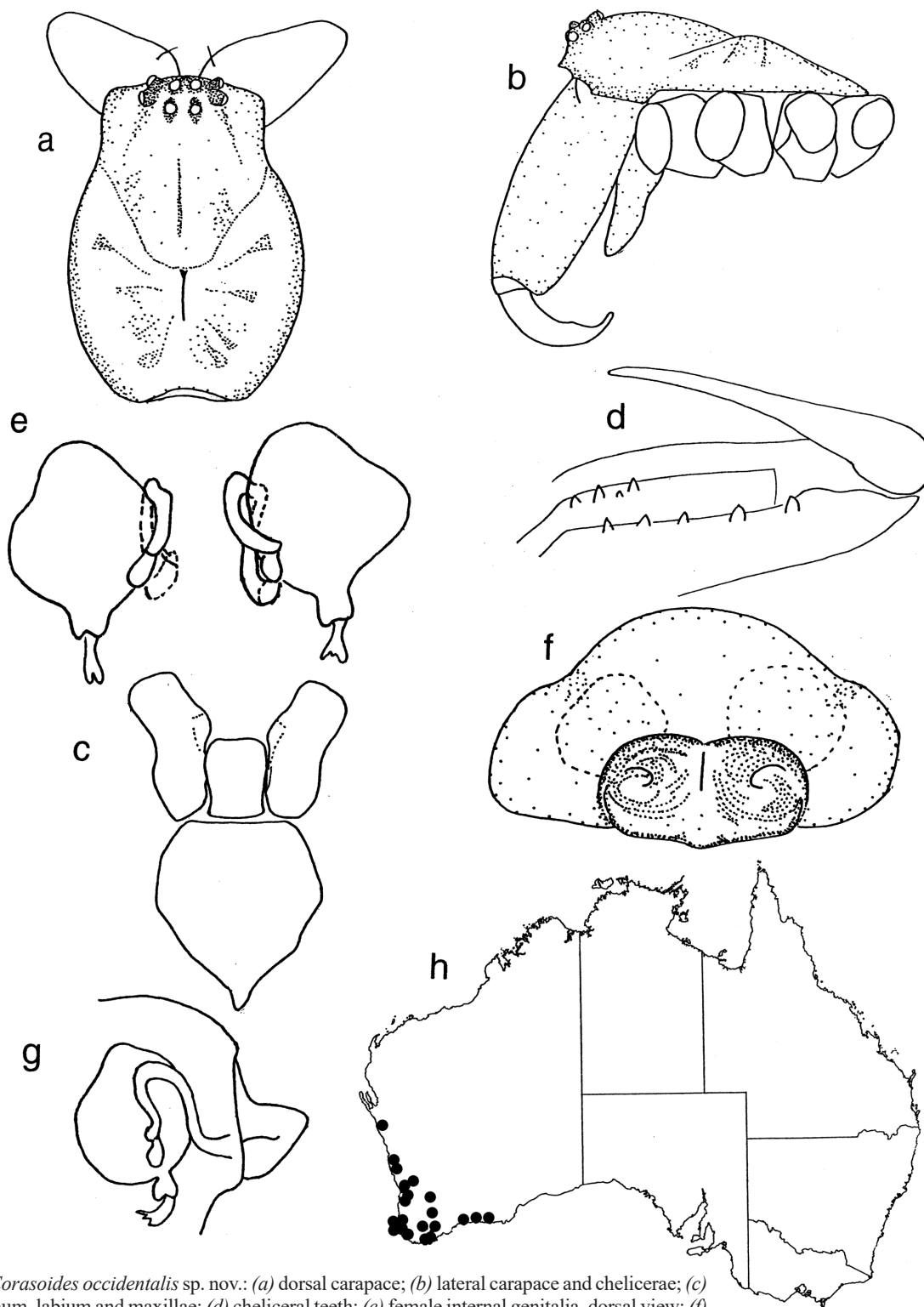

Figure 27. *Corasoides occidentalis* sp. nov.: (a) dorsal carapace; (b) lateral carapace and chelicerae; (c) ventral sternum, labium and maxillae; (d) cheliceral teeth; (e) female internal genitalia, dorsal view; (f) female epigyne, ventral view; (g) female epigyne and internal genitalia, lateral view; (h) distribution.

Spination. Leg I: femur d2,2,2,1,1,1,2,3; tibia v1,1; metatarsus v2,2,2. Leg II: femur d3,3,1,3,3,3; tibia v1,1 p1; metatarsus v1,1,2 p1,1 r1. Leg III: femur d3,3,3,3,3; tibia d1,1,1,2 p1; metatarsus; d1,1,1,1,2 v2,2,2 p1,1. Leg IV: femur; 1,1,1,3,2,1,3; tibia; d1 p1 r1,1; metatarsus; d1,1,1,2,2,2, v1,1,1,1,1,2 p1,1 r1. Palp: femur; d1,2,3; patella: d1; tibia; p1; tarsus several. **Male palp.** Digitiform portion very long, cymbium length up to six times diameter of palpal bulb but as little as four times in some small

males. Bristled retroventral tibial apophysis present. Ventral apophysis partially membranous. Retrolateral apophysis long, tapering, curving and twisting slightly away from palp retrolaterally, reversing slightly and with final spine-like portion inclining towards base of cymbium for up to one third its own length, the medial section becoming more bent in specimens from north to south (Figs 29a–d). Conductor stalked with wide base. Conductor tip sclerotized, smooth, with sclerotized, semicircular flange around ventral/

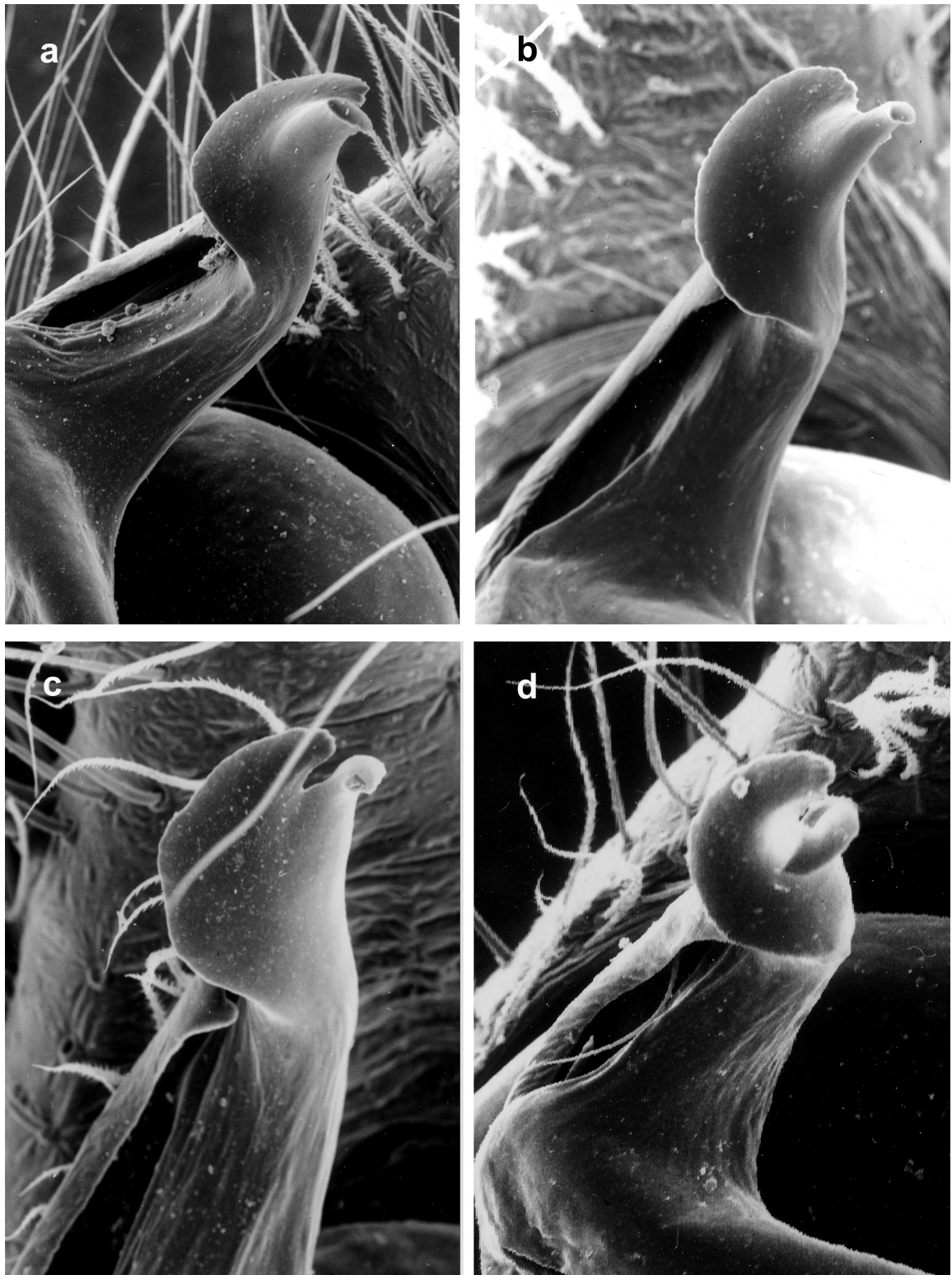

Figure 28. *Corasoides occidentalis* sp. nov., conductor tips: (a) Perth, WA; (b) Stirling Ranges, WA; (c) Gelorup, WA; (d) Albany, WA.

prolateral side for about 180° (Fig. 26a–c,e,f). Embolus long, spine-like, arising basally. Single row of 6 trichobothria on cymbium of specimens from type locality but 4–7 according to locality and size of specimen. **Abdomen.** Tail of spigots present on anterior lateral spinnerets.

Female (Fig. 27e–h), similar to male. CL 6.0 (6.8), CW 4.3 (5.1), AL 6.1, AW 3.4, HW 3.3, EpGW 1.5, MOQL

0.82, MOQAW 0.61, MOQPW 0.73, SL 3.0, SW 2.4, ML 2.3, MW 1.1, LL 1.3, LW 1.1, ChelL 2.9 (4.5), ChelW 1.7 (2.3), clypeus height 0.8. Chelicerae. Prominent pair of cheliceral bristles may or may not be reduced. Other bristles on chelicerae may be as long and almost equally robust. Cheliceral teeth: retromarginal 5, promarginal 3(4). Transverse ridges present between teeth margins. Leg lengths:

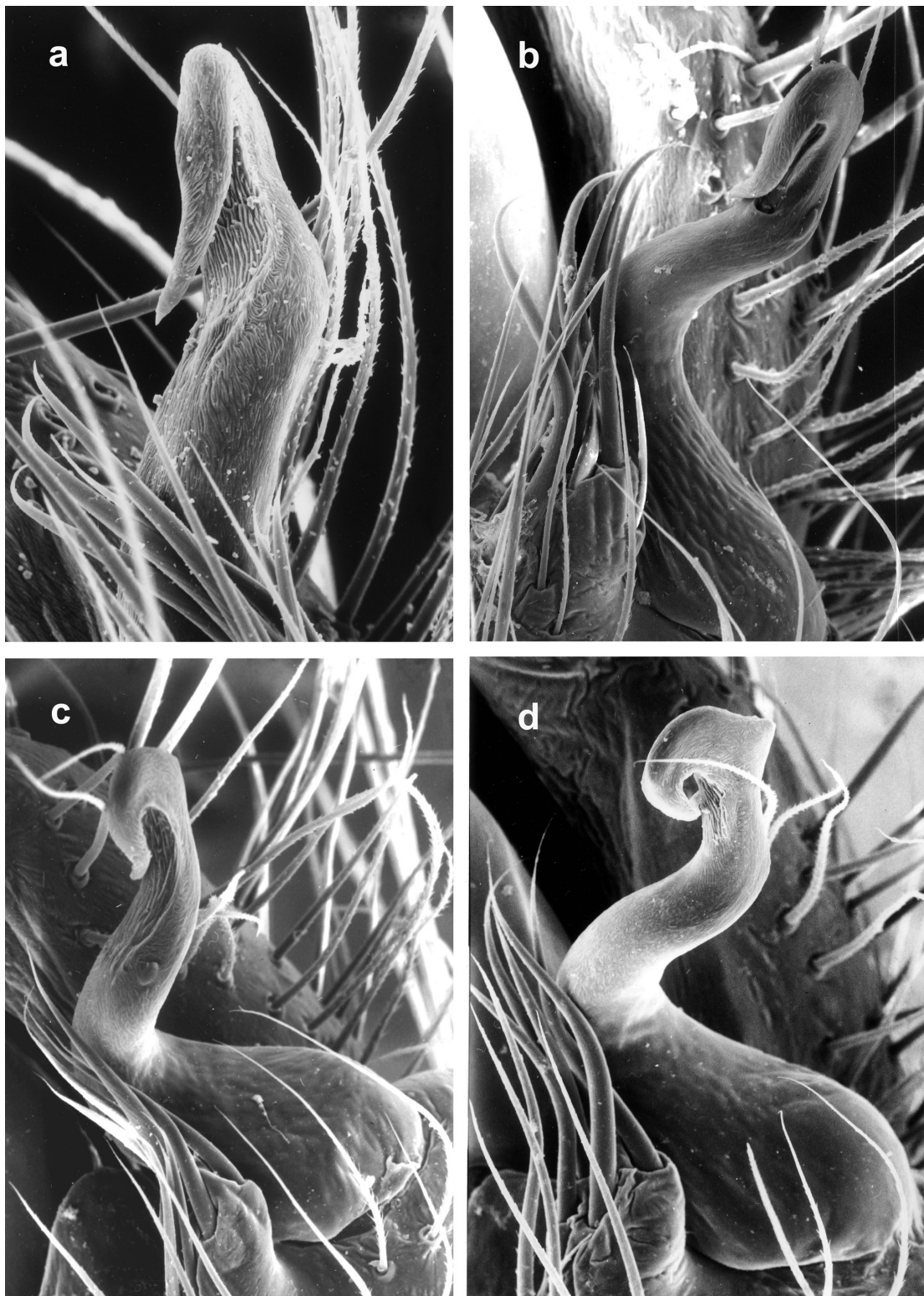

Figure 29. *Corasoides occidentalis* sp. nov., retrolateral apophyses: (a) Perth, WA; (b) Stirling Ranges, WA; (c) Gelorup, WA; (d) Albany, WA.

	I	II	III	IV	Palp
femur	7.0	6.0	4.9	6.9	3.6
patella	2.3	2.3	1.6	2.0	1.1
tibia	6.3	5.0	4.0	5.9	2.1
metatarsus	7.1	5.6	5.6	7.8	—
tarsus	2.9	1.8	1.8	2.4	2.9
total	25.5	20.6	17.9	24.8	9.8

Trichobothria on first tarsus, 6, increasing in length distally. **Spination.** Leg I: femur d1,3,3,3,3; tibia v1,2 p1; metatarsus d2 v2,2,2 p1,1. Leg II: femur d1,3,3,3,3; tibia v1,1,2 p1; metatarsus d1,1,2 v2,2,2 p1,1. Leg III: femur d2,3,3,1,3,3; tibia d1,1 v1,2,2 p1 r1,1; metatarsus d1,2,2,2, v2,2,2. Leg IV: femur d1,1,1,1,1,1,3; tibia v2,2,2p1 r1,1; metatarsus d1,1,1,1,2 v1,1,1,1,1,2. Palp: femur d1,1,1,1,3

p1; patella d1; tibia d1 p1. **Epigyne** (Fig. 27f). Width almost twice length. Long hairs directed posteriorly from anterior and sides. Scape protruding ventrally at almost 90° (Fig. 27g). Lateral extension of scape extending to lateral margins of genital atria. Genital openings situated in posterior half of epigyne. Spermathecae large. Insemination ducts weakly convoluted (one full bend) with posteriorly directed diverticula where insemination ducts join spermathecae (Fig. 27e,g).

Habitat. Heathland, woodland, dry and wet sclerophyll forest.

Distribution. Coastal western and south western Western Australia, from Kalbarri National Park to Cape Le Grande and inland as far as Corrigin (Fig. 27h), following Thornthwaite's (1948) humid and sub-humid zones.

Remarks. *Corasoides occidentalis* varies in size and morphology over its distribution. Small males become more common north of Cervantes, east of Fitzgerald River National Park and in general with increasing aridity and distance from the coast. The length of the cymbium and the number of trichobothria on it appears to vary directly according to the size of the specimen. Figure 26g shows the number of cymbial trichobothria decreasing from six or seven on the mid west coast of their distribution surrounded by a band of four or five and reducing to two or three trichobothria on the southern coast where males tend to reach their smallest size.

The width of the epigyne also varies. The width is greatest in the Glen Forrest and west coast areas and decreases eastward and inland in a geographical variation similar to that of the cymbial trichobothria.

The only observed discrete difference in morphology was the presence of a bifurcate tip to the retrolateral apophysis in some specimens from Glen Forrest (Fig. 19a). All other differences in morphology, particularly with respect to the conductor tip (Fig. 28a–d) and the height and twisting of the retrolateral apophysis (Fig. 29a–d) were due to individual variation or were continuous geographically. A distinct pit with an inner structure is present beneath the tip of the retrolateral apophysis in specimens from Stirling Ranges (Fig. 29b) but is absent in specimens from Perth, Gelorup and Albany (Fig. 29a,c). A less clearly defined pit structure is present in specimens from Glen Forrest. Similarly, a protrusion or crest on the outer final bend of the retrolateral apophysis (Fig. 29d) is present on specimens from Albany and to a lesser extent from Gelorup (Fig. 29c) but appears to be absent from specimens from other regions.

This species is sympatric with *C. australis* in some areas, e.g., Toodyay, Corrigin and some areas between Greenough and Cervantes.

Etymology. From the Latin, *occidentalis*, meaning “of the falling sun” or “of the west” and referring to the western distribution in Australia of this species.

Corasoides stellaris sp. nov.

Figs 30, 31

Holotype ♀, Papua New Guinea, Townsville drilling site, SE slope of Mt Akric, 15 km NW Tabubil, Western Province, 5°10'S 141°9'E, 1625m, Nov. 1996, M. Humphrey M. Moulds, KS.71837 (AM).

Other material examined. 1 juvenile, same data as holotype, discarded after electrophoretic work.

Diagnosis. The length and width of the epigyne of this species are almost equal, unlike the dimensions of the epigyne of closely related *C. angusi* sp. nov. and *C. nimbus* sp. nov. In addition *C. stellaris* sp. nov. can be distinguished from these two latter species by the width of the lateral extension of the scape that is well over half the width of the epigyne (Fig. 31a). *Corasoides stellaris* sp. nov. can also be distinguished by the number and configuration of the insemination ducts and the presence in *C. stellaris* sp. nov. of a large, curved diverticulum at the site of entry into the seminal receptacle (Fig. 31b–d).

Description. Medium to large spider. **Carapace.** Pale basic pattern. **Abdomen.** Basic generic pattern but with dorsolateral stripes reduced to the anterior quarter of the abdomen (Fig. 30a).

Female (Figs 30, 31). CL 5.7, CW 4.6, AL 6.6, AW 4.9, HW 2.9, EpGW 1.8, MOQL 0.83, MOQAW 0.72, MOQPW 0.89, SL 2.7, SW 2.5, ML 1.8, MW 1.2, LL 1.1, LW 0.9, ChelL 2.8, ChelW 0.94, clypeus height 0.5. **Cephalothorax** (Fig. 30). Sternum roughly broad as wide with long but blunt point. Labium basally notched. Maxillae broad. **Chelicerae.** Robust (Figs 30b, 31e). Teeth: retromarginal 5, promarginal 3(4), evenly spaced but uneven in size (Fig. 30c). No ridges between margins. Leg lengths:

	I	II	III	IV	Palp
femur	10.0	9.0	7.1	9.8	6.9
patella	2.3	2.1	1.8	1.9	2.0
tibia	10.0	6.9	5.4	8.0	3.9
metatarsus	10.9	8.0	8.0	11.6	—
tarsus	5.0	4.9	3.3	4.0	4.0
total	38.2	30.9	25.5	35.3	16.8

Spination. Leg I: femur d1,3,3,1,2,2; tibia v1,1; metatarsus d2 v1,1,1,1,1. Leg II: femur d2,1,3,1,3,3,2; tibia v1,2; metatarsus d1,1 v2; Leg III: femur d3,2,2,2,2, p1,1,1,1; tibia d1,1,2 v1,2,2; metatarsus d1,1,1,1,1,2 v1,2,2,3. Leg IV: femur d2,1,1,1,1,2,1,1; tibia d1,1,1,3; metatarsus d1,1,2,2,4 v1,2,1,2,2; palp: femur d1,1,3; patella d1,1; tibia d1,1; tarsus several. Three trichobothria on 1st tarsus. **Abdomen.** Anterior lateral spinnerets with tail of small spigots. **Epigyne** (Fig. 31a). Length almost equal to width. Anterior and lateral portions covered with long, posteriorly directed hairs. Genital openings near transverse midline, scape stalk much narrower than diameter of one genital opening. Lateral extensions of scape long and wide, continuing beyond margin of genital openings. Insemination ducts mostly anterior to seminal receptacles, proceeding anteriorly from genital openings and with at least four bends. Large, curved diverticulum at site of entry into each spermatheca. This diverticulum is an extension of the insemination duct beyond its entry into the spermatheca (Fig. 31b–d).

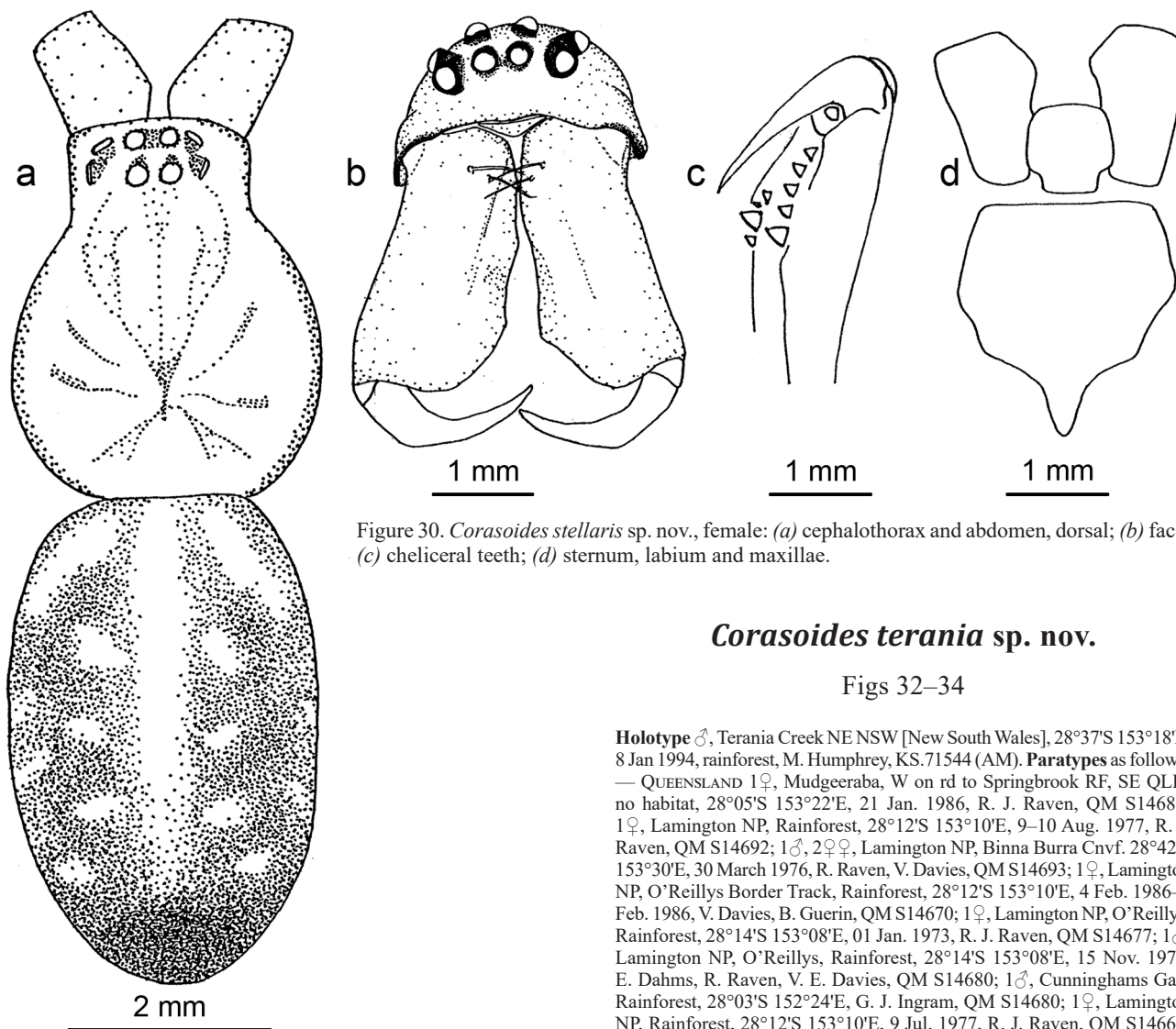

Figure 30. *Corasoides stellaris* sp. nov., female: (a) cephalothorax and abdomen, dorsal; (b) face; (c) cheliceral teeth; (d) sternum, labium and maxillae.

Corasoides terania sp. nov.

Figs 32–34

Holotype ♂, Terania Creek NE NSW [New South Wales], 28°37'S 153°18'E, 8 Jan 1994, rainforest, M. Humphrey, KS.71544 (AM). **Paratypes** as follows: — QUEENSLAND 1♀, Mudgeeraba, W on rd to Springbrook RF, SE QLD, no habitat, 28°05'S 153°22'E, 21 Jan. 1986, R. J. Raven, QM S14689; 1♀, Lamington NP, Rainforest, 28°12'S 153°10'E, 9–10 Aug. 1977, R. J. Raven, QM S14692; 1♂, 2♀, Lamington NP, Binna Burra Cnfv. 28°42'S 153°30'E, 30 March 1976, R. Raven, V. Davies, QM S14693; 1♀, Lamington NP, O'Reillys Border Track, Rainforest, 28°12'S 153°10'E, 4 Feb. 1986–5 Feb. 1986, V. Davies, B. Guerin, QM S14670; 1♀, Lamington NP, O'Reillys, Rainforest, 28°14'S 153°08'E, 01 Jan. 1973, R. J. Raven, QM S14677; 1♂, Lamington NP, O'Reillys, Rainforest, 28°14'S 153°08'E, 15 Nov. 1977, E. Dahms, R. Raven, V. E. Davies, QM S14680; 1♂, Cunninghams Gap, Rainforest, 28°03'S 152°24'E, G. J. Ingram, QM S14680; 1♀, Lamington NP, Rainforest, 28°12'S 153°10'E, 9 Jul. 1977, R. J. Raven, QM S14668; 3♀, Lamington NP, Nagarrigoon, Rainforest, 28°42'S 153°30'E, 08 Apr. 1976, Queensland Museum Party, QM S14686 (QM). — NEW SOUTH WALES 1♀, KS.71545; 2♀, 1♂, KS.71546; 2♀, KS.71547, same data as holotype; 1♂, Mt Nardi, 28°33'S 153°17'E, 22 Dec. 1991, M. Humphrey, KS.71548; 1♂, same data, KS.98073; 3♂, Mt Nardi, Nightcap NP, NSW, 28°33'S 153°20'E, 03 Oct. 1991, KS.71549; 3♀, same data, KS.71550; 1♂, same data, KS.71551; 1♀, same data, KS.71557; 1♂, 1♀, Mt Nardi, 28°33'S 153°17'E, 3 Oct 1991, KS.71552; 1♀, hatched from material, 14 Feb. 1992, died 24 Feb 1993, KS.71553; 1♀, Border Ranges NP, 28°20'S 153°05'E, 29 Sept 1991 KS.71554; 1♂, same data, KS.71555; 1♀, Mt Nardi, Nightcap NP, 28°33'S 153°20'E, 30 Oct. 1991, M. Humphrey, KS.71556; 1♀, Minion Falls, NE NSW, 28.612°S 153.390°E, May 2005, M. Humphrey & M. S. Moulds, KS.98070 (AM). 1♂, Whian Whian SF, 28°41'S 153°19'E, 12.ix.1976, R. J. Raven, QM S14688 (QM).

Other material examined. — QUEENSLAND 1♀, 1 pen ♂, Lamington NP, O'Reillys, Rainforest, 28°14'S 153°08'E, 22 Jun 1973, R. J. Raven, QM S14674; 1 pen ♂, Lamington Plateau, rainforest, 28°19'S 153°04'E, 13 Apr. 1974, R. J. Raven, QM S14681 (QM). — NEW SOUTH WALES 1♀, Border Ranges NP, 28°20'S 153°05'E, 29 Sept 1991; 5 juv., 03 Oct 1991; 2 pen ♂♂, 30 Oct 1991; 1♀, Mt Nardi, Nightcap NP, 28°33'S 153°20'E, 03 Oct. 1991, M. Humphrey; 1 juv., Wiangaree SF, 28°23'S 153°06'E, 16 Nov 1974, KS.3566; 1♀, Wiangaree SF, 28°23'S 153°06'E, 16 Nov 1974, KS.4898 (AM); 1 juv., Mt Warning, 28°25'S 153°17'E, 03 Dec. 1974, R. J. Raven, QM S14690; 1 juv., Nothofagus Mtn, 12 km N Woodenbong, Rainforest, 28°17'S 152°37'E, 4–6 Feb. 1982, G. Monteith, D. Yeates, QM S14671 (QM).

Diagnosis. Distinguished from other Australian species by the absence of a retroventral tibial apophysis in the male.

Male. Unknown.

Remarks. This species is sympatric with *C. cowanae* sp. nov. The juvenile mentioned in *Other material examined*, was collected 2 m from the holotype collection site. This specimen, which was too large to be *C. cowanae* sp. nov., was tentatively identified as *C. stellaris* sp. nov. and results from allozyme electrophoresis work (Humphrey, 2010) confirmed this identification.

Habitat. Both specimens were collected from horizontal sheet webs under an overhanging earthen embankment by the side of a creek in an area of cleared rainforest. The retreat was in a natural crevice in the embankment.

Distribution. Known only from holotype location, south east slope of Mt Akric, 15 km north west of Tabubil, Western Province, Papua New Guinea (Fig. 31f).

Etymology. From the Latin, *stella*, a star, suggestive of the type locality in the Star Mountains, Papua New Guinea.

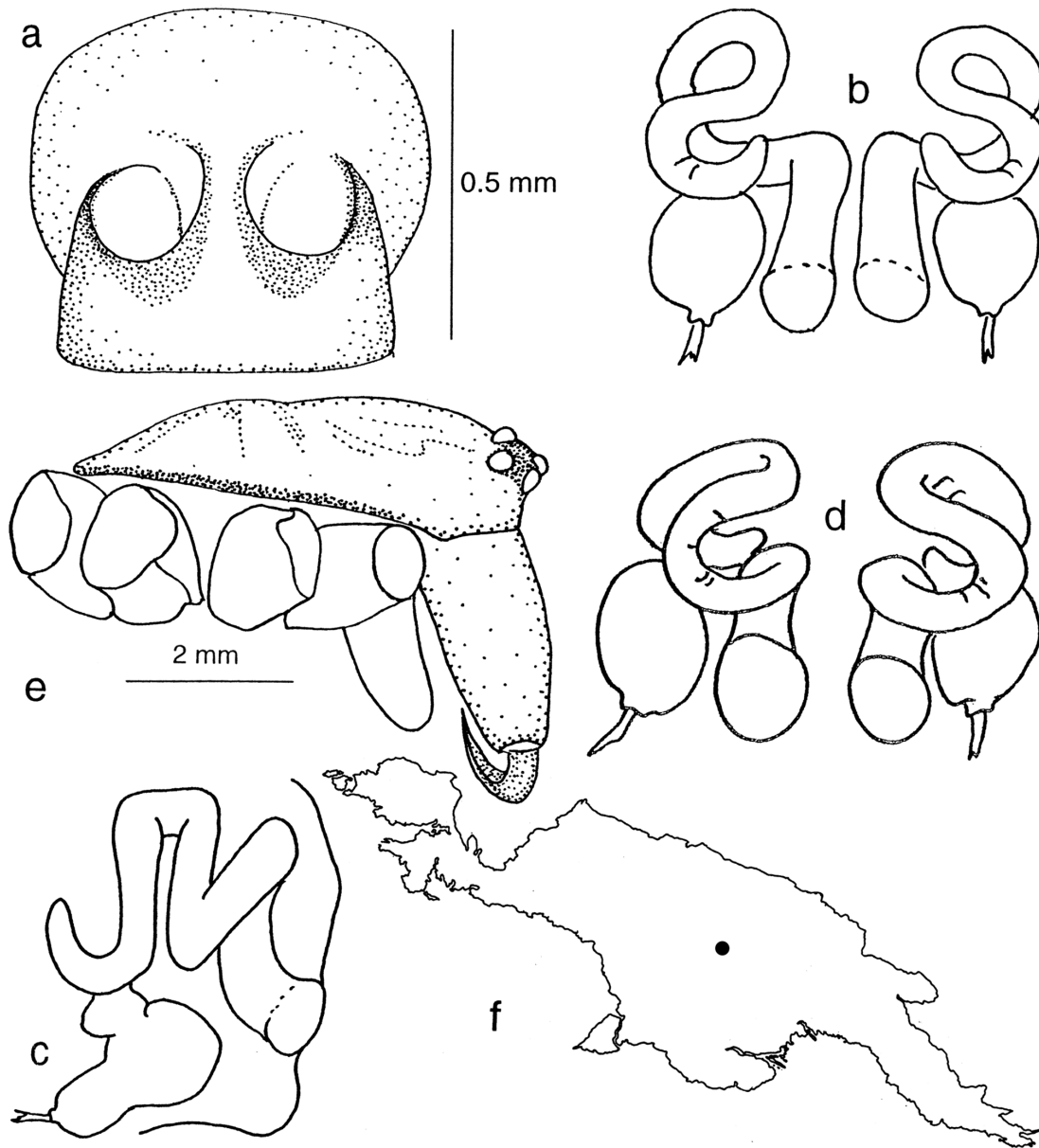

Figure 31. *Corasoides stellaris* sp. nov., female: (a) epigyne, ventral; (b) internal genitalia, dorsal; (c) internal genitalia, lateral from centre; (d) internal genitalia, ventral; (e) carapace, lateral; (f) distribution

Retrolateral apophysis with basal section broader than its height. Female epigyne twice as wide as long with the genital atria occupying most of the width. Long, finger-like diverticulum at site of entry of insemination ducts.

Description. Medium to large spider. **Carapace.** Full pattern for genus. **Abdomen.** Basic pattern with dorsolateral stripe extending to at least two thirds length of abdomen (Fig. 33a).

Male (Figs 32, 33a,e–g, 34a). CL 5.6 (4.4–6.6), CW 4.4 (3.7–4.5), AL 5.5, AW 3.1, HW 2.7, EpGW 1.6, MOQL 0.88, MOQAW 0.69, MOQPW 0.75, SL 2.6, SW 2.4, ML 2.4, MW1.1, LL 1.3, LW 0.6, ChelL 3.8 (2.8–5.6), ChelW 1.4 (1.1–1.9), clypeus height 0.4. **Cephalothorax.** Sternum longer than wide, distinct point distally (Fig. 33e). Labium notched basally, barely rebordered. **Chelicerae.** Long, often curved or bent in males (Fig. 32d). Cheliceral teeth: retromarginal 6, promarginal 3; evenly spaced, uneven size (Fig. 33f) Transverse ridges present between teeth margins. Leg lengths:

	I	II	III	IV	Palp
femur	11.9	4.7	8.3	11.3	4.8
patella	2.5	2.1	0.9	2.0	1.3
tibia	11.8	8.3	3.3	9.3	1.3
metatarsus	13.8	10.8	4.8	14.0	—
tarsus	2.1	3.3	2.6	3.0	4.4
total	42.1	33.8	28.9	39.5	11.6

Spination. Leg I: femur d3,2,2,2,1,3,3,2; tibia v2,2,2,2; metatarsus v2,2,1,1,2,2 p1,1 r1. Leg II: femur d3,2,2,3,3,1,3,3; tibia v2,2,2,3; metatarsus d1,2 v1,1,2,2. Leg III: femur d3,2,2,1,3,1,3 p1,1,1,1; tibia d1,2,1 v2,2,2,2; metatarsus d2,2,2,2 v1,2,2,2,2. Leg IV: femur d1,2,2,2,1,1,1,3; tibia d1,1,1,1,1,2 v2,2,2,2; metatarsus d2,1,2,1,2,1,2,2 v2,2,2,1,2; Palp: femur d1,1,1,1,1; tarsus several. **Male palp.** Digitiform portion of cymbium long and curved, cymbium length approximately 4 times diameter of bulb. Retroventral apophysis absent. Ventral apophysis spout-like, rebordered prolaterally. Retrolateral apophysis with wide basal section.

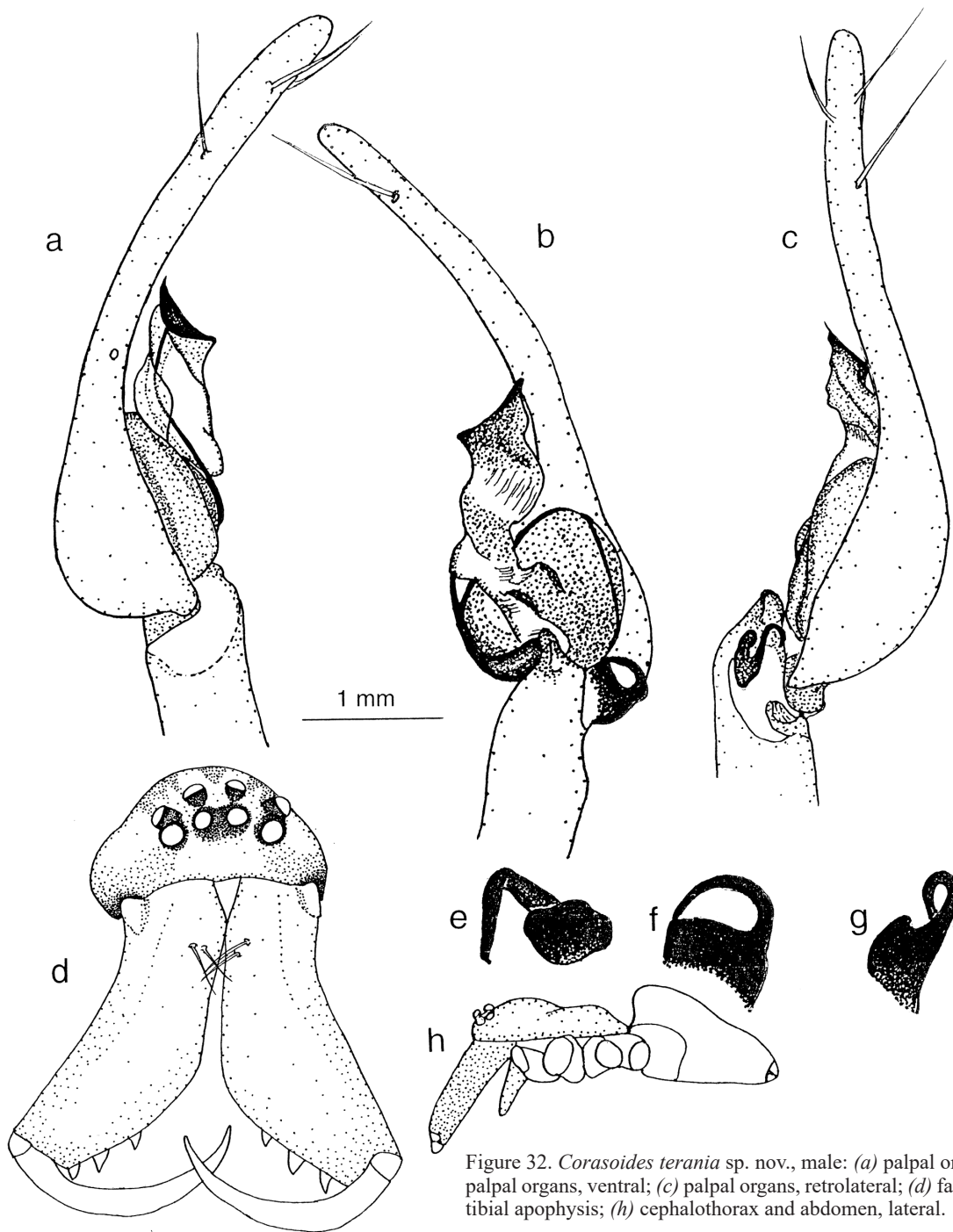

Figure 32. *Corasoides terania* sp. nov., male: (a) palpal organs, prolateral; (b) palpal organs, ventral; (c) palpal organs, retrolateral; (d) face; (e–g) retrolateral tibial apophysis; (h) cephalothorax and abdomen, lateral.

Spine-like process of apophysis originates from retrolateral corner of the basal section and curves towards bulb finishing near the opposite side of the base (Figs 32e–g). Embolus arises basally. Conductor stalked, appearing wide at base. Conductor tip straight, untwisted, cone-shaped, without ridges, pointing antero-retrolaterally. Trichobothria on cymbium: single row of 5 on dorsum, decreasing in size basally. **Abdomen.** Tail of small spigots on anterior lateral spinnerets.

Female (Figs 33b–d, 34b), similar to male. CL 5.3 (4.9–6.6), CW 4.3 (3.6–4.1), AL 8.5, AW 4.1, HW 2.8, EpGW 1.6, MOQL 0.81, MOQAW 0.69, MOQPW 0.81, SL 3.0, SW 2.7, ML 2.2, MW 1.3, LL 1.3, LW 1.1, ChelL 3.3 (2.6–3.4),

ChelW 1.4 (1.1–1.6), clypeus height 0.5. **Chelicerae.** Teeth: retromarginal 6, evenly sized and spaced; promarginal 4. Leg lengths:

	I	II	III	IV	Palp
femur	9.8	8.1	7.0	9.4	3.4
patella	2.4	2.0	7.0	1.9	1.4
tibia	8.9	6.8	1.6	7.0	1.9
metatarsus	10.6	8.4	5.6	11.8	—
tarsus	3.8	2.4	8.0	2.9	2.8
total	35.4	27.7	1.9	33.0	9.5

Spination. Leg I: femur d3,4,2,1,3,3,3,3; tibia v2,2,2,2; metatarsus v2,2,2. Leg II: femur d3,4,3,3,1,3; tibia v2,2,2,2

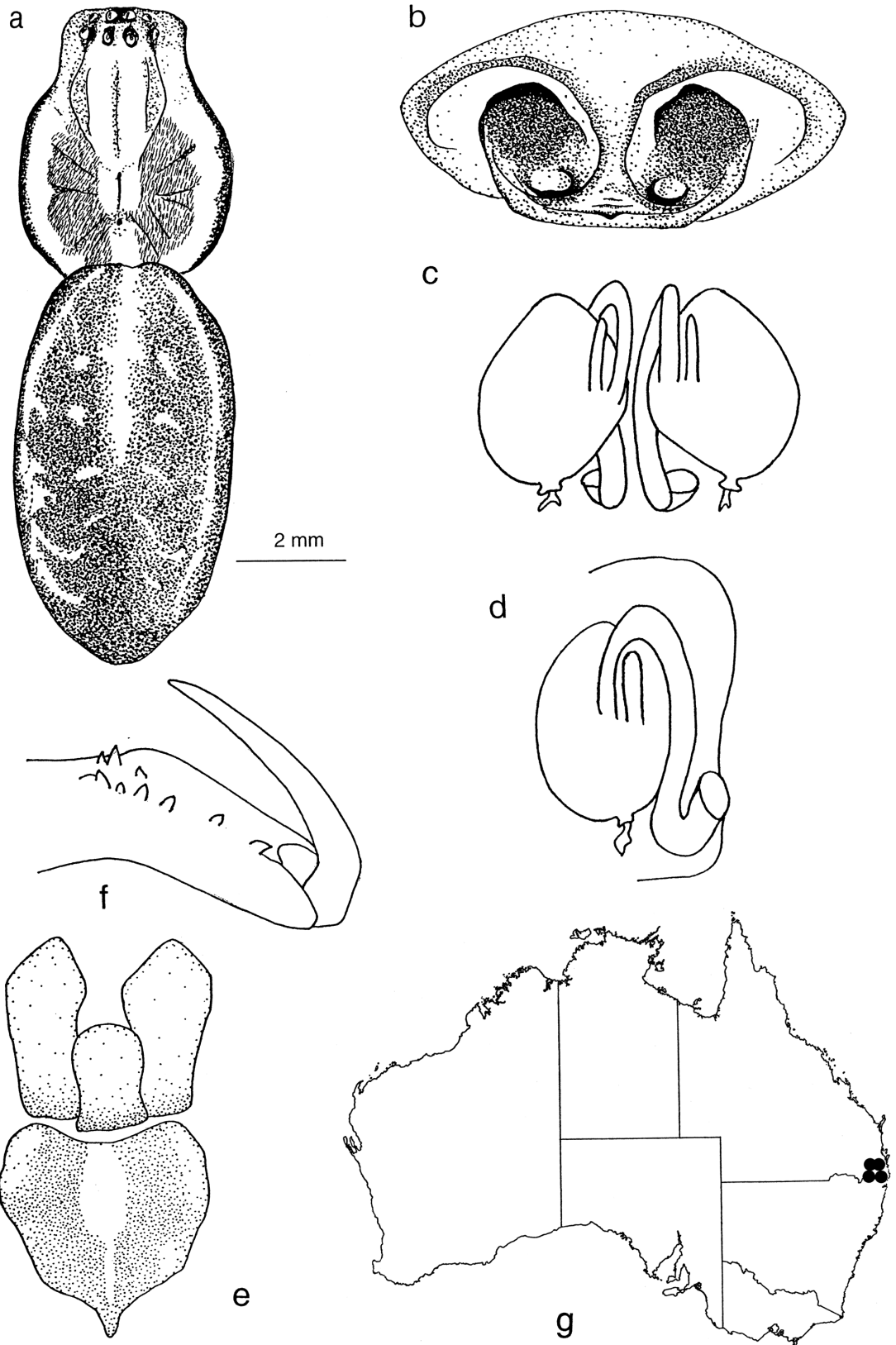

Figure 33. *Corasoides terania* sp. nov.: (a) carapace and abdomen, ventral; (b) female epigyne, ventral; (c) female internal genitalia, dorsal; (d) female internal genitalia, lateral from centre; (e) ventral sternum, labium and maxillae; (f) cheliceral teeth, male; (g) distribution.

p1,1 r1; metatarsus v2,2,2p1,1. Leg III: d3,4,2,3,3 p1,1,1; tibia d1,1 v2,2,1,2 p1,1,1 r1; metatarsus d1,2,2,2 v1,1,1,1,2 p1,1,1. Leg IV: femur d1,2,1,2,4,3; tibia d1,1 v2,1,1,1,2 p1,1,1 r1; metatarsus d1,1,1,2,2 v2,2,2,2. Palp: femur d1,1,1,1,1; tibia

d1; tarsus several. Trichobothria on 1st tarsus: one row of 5. **Epigyne** (Figs 33b, 34b). Width twice length. Atria of genital openings occupying almost all width. Almost hairless except for sparse row on anterior of scape directed towards genital

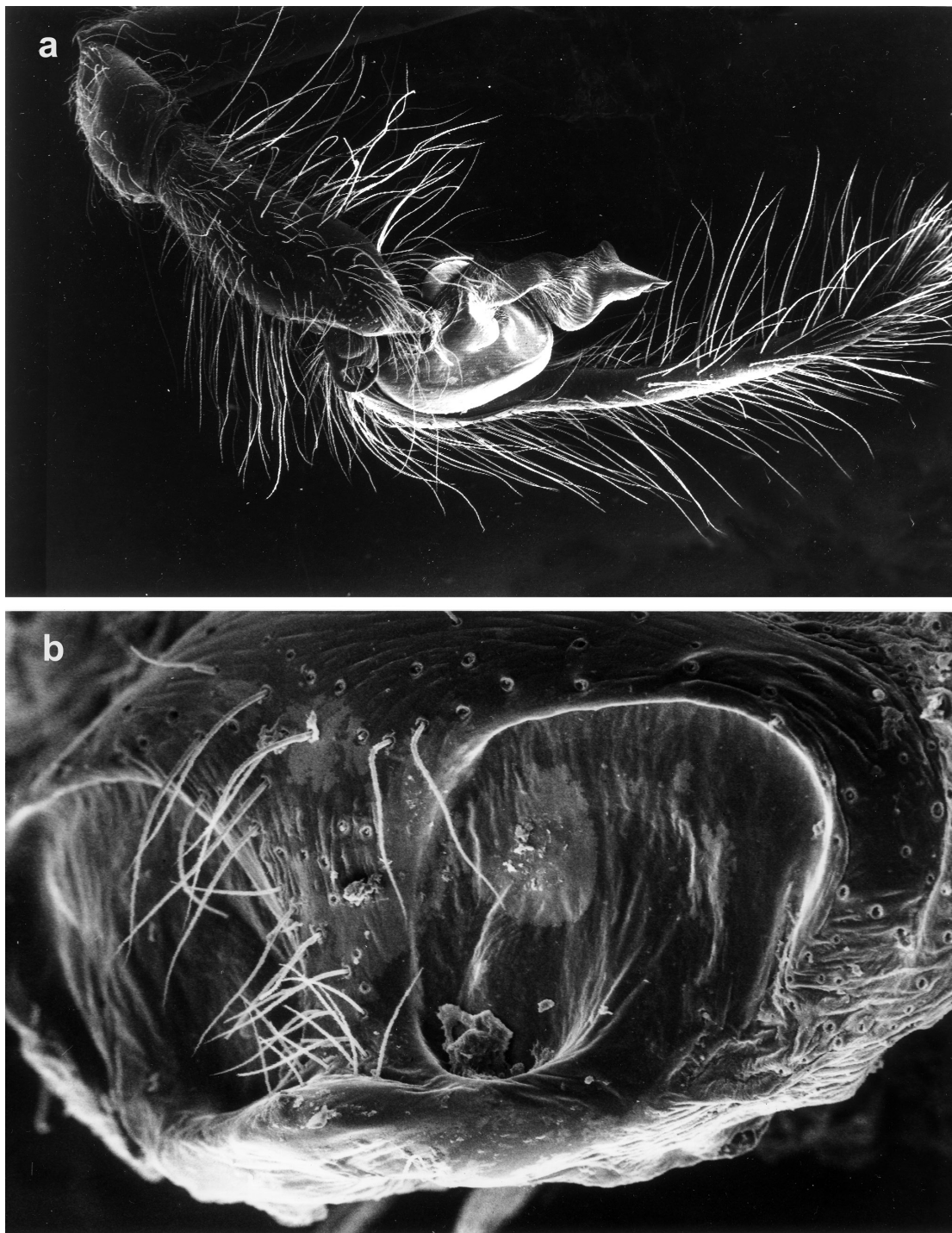

Figure 34. *Corasoides terania* sp. nov.: (a) male palp, Border Ranges NP NSW; (b) epigyne, Border Ranges NP NSW.

atria. Small projection midline at posterior end of scape. Scape stalk very narrow, less than one-quarter of width of a genital atrium. Lateral extension of scape short, approximately half diameter of a genital atrium. Initiation of insemination ducts posterior, entering below spermathecae. Insemination ducts weakly convoluted (2 bends). Long, finger-like diverticula at site of entry into spermathecae (Fig. 33c,d).

Habitat. Warm temperate/sub-tropical rainforest. Webs commonly found extending from crevices in tree trunks, epiphytes, fallen logs and other debris, 0.2–2.0 m from the

ground, especially where there is a slight break in the tree canopy.

Distribution. Rainforest region in vicinity of Cunningham's Gap, Lamington National Park, MacPherson Ranges, Queensland and Border Ranges National Park, Mt Warning National Park and south to Nightcap National Park, Mt Nardi and Terania Creek, New South Wales (Fig. 33g).

Etymology. Named after the type location (nominative in apposition), Terania Creek, New South Wales.

Phylogenetic analyses

Phylogenetic relationships were determined by cladistic analyses using morphological characters supplemented by behavioural, chromosomal and ecological attributes.

All analyses were carried out using the computer program PAUP*, version 4.0b2 (Swofford, 1998), employing an heuristic search using default settings. Trees were printed via CLADOS version 1.2 (Nixon, 1992). Characters were optimized using the default setting that favoured parallel developments over reversals (DELTRAN). All characters have been given equal weighting and all except one 5-tiered morphological character (character 18) have been treated as unordered. Missing data or inappropriate data are indicated by “?”.

Two outgroups were selected, *Cambridgea fasciata* Koch, 1872 and *Inola subtilis* Davies, 1982. *Inola subtilis* was chosen following the results of electrophoretic work (Humphrey, 2015). *Cambridgea fasciata* was chosen because of its morphological similarity to *Corasoides* and the taxonomic placing of *Cambridgea* near *Corasoides* by Forster & Wilton (1973) and Davies (1988).

Characters

The following characters and character states were used in the analysis. The data matrix from these characters is shown in Table 1.

Web

Character 0. Weave pattern: (0) irregular; (1) regular, square to rectangular.

General morphology

- Character 1. Ventral extension of chelicerae (at least in male): (0) well beyond level of labium; (1) equal to or marginally beyond labium.
- Character 2. Two pairs of prominent cheliceral bristles (at least in male): (0) absent; (1) present. [Note. These bristles are sited on the upper half of the chelicerae and usually cross each other in front of and between the two chelicerae (Fig. 13d).]
- Character 3. Size of two pairs of prominent cheliceral bristles in character 2: (0) normal, prominent, crossing; (1) prominent but reduced, not or barely crossing. [Note. Female *Corasoides* tend to have larger numbers of hairs and smaller cheliceral bristles than males. In species where the cheliceral bristles are reduced in the male, the usually prominent bristles of the females are often almost the same size and robustness as other bristles on the chelicerae.]
- Character 4. Serrations on fangs: (0) present; (1) absent. [Note. In some species serration is not obvious and its detection is compounded by the false absence in some specimens, caused, presumably, by wear and tear.]
- Character 5. Form of fangs: (0) short, curved; (1) long: (2) short, angular, chunky.
- Character 6. Prominence of boss: (0) prominent; (1) reduced.
- Character 7. Relative number of promarginal and retromarginal teeth: (0) equal; (1) more promarginal; (2) more retromarginal.
- Character 8. Presence of enlarged prolateral cheliceral teeth in adult males: (0) absent; (1) present. [Note.

This attribute may not be displayed to full extent in all specimens.]

- Character 9. Cheliceral grooves: (0) absent; (1) present. [Note. Cheliceral grooves are transversely placed between the rows of cheliceral teeth.]
- Character 10. Length of cephalothorax: (0) greater than 3 mm; (1) less than 3 mm.
- Character 11. Banding on legs: (0) banded; (1) not banded. [Note. Faint banding on any part of the legs is scored (0). In faded alcohol specimens banding can usually still be seen on the femora of leg IV.]
- Character 12. Spines on patella of leg III, at least in male: (0) absent; (1) present. [Note. In some specimens the patella spine(s) may be reduced to large bristles.]
- Character 13. Tail of pyriform spigots prolaterally on anterior lateral spinnerets: (0) absent; (1) present (Fig. 3b,c)

Female genital morphology

- Character 14. Presence of beak on epigyne: (0) absent; (1) present. [Note. Beak is ventral projection anterior to scape, as an extension to the ridge anterior to the genital openings (Figs 16e,g, 23c,f).]
- Character 15. Lateral extension of scape: (0) present; (1) absent.
- Character 16. Plugging of female epigyne during mating: (0) plugged; (1) not plugged. [Note. Although this could be described as a behavioural character, it is observed as a physical state of the female genitalia. A single plugged female scores (0) for a species. To be scored (1) at least five adult females in the vicinity of adult males must be unplugged. Otherwise is scored as (?).]
- Character 17. Diverticula at junction of insemination ducts and spermathecae: (0) absent; (1) present.
- Character 18. Number of bends in insemination ducts: (0) 0; (1) 1–2; (2) 3–4; (3) 5–7; (4) 8+. [Note. A bend is scored for a change in direction of at least 90 degrees.]
- Character 19. Diameter of insemination ducts: (0) uniform thickness throughout length; (1) at least twice the thickness in the initial section as in the remainder (Fig. 31d). [Note. The length of the initial section is at least the length of the diameter of the spermathecae.]
- Character 20. General position of loops of insemination ducts with respect to spermathecae: (0) central, between spermathecae; (1) anterior; (2) evenly looped around spermathecae. [Note. General position of loops of insemination ducts with respect to spermathecae is associated to some extent with character 18. It is useful really only for those species with numerous bends in the insemination ducts as it defines the position of these extra bends. Where insemination ducts are simple, they generally lie between the spermathecae and this is the case with both outgroups. *Corasoides angusi* sp. nov. is scored “?” because the insemination ducts are as much anterior as between the spermathecae and as such is intermediate in state.]

Male papal morphology

- Character 21. Bristled retroventral apophysis: (0) absent; (1) present.
- Character 22. Retrolateral apophysis: (0) absent; (1) present.
- Character 23. Retrolateral apophysis morphology: (0) does not taper to point; (1) tapers to point.

Table 1. Character matrix of the 35 characters scored for the ten species of *Corasoides*. Missing data are scored as “?”. Note that numbering of characters begins with zero.

species	11111		11111		22222		33333	
	01234	56789	01234	56789	01234	56789	01234	
<i>Inola subtilis</i> (outgroup)	000?0	00000	00000	?0000	0000?	?0000	00000	
<i>Cambridgea fasciata</i> (outgroup)	000?0	10101	00000	??010	00100	0010?	?0?00	
<i>Corasoides angusi</i> sp. nov.	11100	10200	00010	10120	?011?	1010?	?0001	
<i>Corasoides stellaris</i> sp. nov.	11100	10200	00010	1?121	10???	?????	?0?01	
<i>Corasoides nimbus</i> sp. nov.	11100	10200	00010	11141	1011?	1031?	?0101	
<i>Corasoides cowanae</i> sp. nov.	11101	21210	10101	01041	1011?	3031?	?0101	
<i>Corasoides nebula</i> sp. nov.	11101	21210	10101	01041	1011?	3030?	?0101	
<i>Corasoides terania</i> sp. nov.	11100	10201	01010	00110	0011?	40201	10000	
<i>Corasoides mouldsi</i> sp. nov.	11100	10201	01010	00110	0111?	21201	10000	
<i>Corasoides motumae</i> sp. nov.	11100	10201	01010	00110	0111?	21201	10010	
<i>Corasoides occidentalis</i> sp. nov.	11110	10201	01010	00110	01111	21201	11010	
<i>Corasoides australis</i>	11110	10201	01010	01130	21111	21301	11110	

Character 24. Pit on retrolateral apophysis (Fig. 29b): (0) absent; (1) present.

Character 25. Direction of retrolateral apophysis: (0) straight in direction of palp; (1) bending towards bulb and then towards base of apophysis (hooked); (2) bending away from bulb, then crossing over ventrally to point obliquely towards the bulb and the base of the apophysis; (3) bending away from bulb; (4) bending towards bulb from far end of base and then pointing dorsally.

Character 26. Conductor morphology: (0) not T-shaped; (1) T-shaped. [Note. The conductors of *C. australis* sp. nov. and *C. motumae* sp. nov. are clearly T-shaped but *C. mouldsi* sp. nov. and *C. occidentalis* sp. nov. are less so. The T-shape is caused by a pair of lobes that enclose the embolus and guide it to the tip of the conductor and are extended basally and prolaterally. These lobes are present, although reduced basally and prolaterally in *C. mouldsi* sp. nov. and *C. occidentalis* sp. nov. but are still scored as “1”. A small, similar looking lobe on *C. terania* sp. nov. is not homologous, being single rather than paired, part of the stalk and not a member of the pair of lobes which guide the embolus into the tip of the conductor.]

Character 27. Degrees of arc through which embolus sweeps from origin to tip: (0) embolus originates centrally; (1) roughly 90 (60–120) degrees; (2) roughly 180 (130–190) degrees; (3) greater than 180 (200+) degrees. [Note. Although this appears to be a continuous character, the states do not overlap. These states define the length of the embolus as well as its position of origin. A centrally originating embolus (as in the genus *Inola*) does not sweep in an arc around the bulb of the cymbium but travels roughly ventrally to the conductor.]

Character 28. Retrodorsal tibial apophysis on male palp: (0) present; (1) absent. [Note. This apophysis is not as obvious, erect or complex as the other male palpal apophyses in *Corasoides*.]

Karyology

Character 29. 2n chromosome number: (0) not equal to 31; (1) equal to 31. [Note. 2n of the outgroup *Inola* is 28 (Tio & Humphrey, 2010).]

Character 30. Number and type of sex chromosomes: (0) XX; (1) XXX. [Note. *Inola* state (XX) is from Tio and Humphrey (2010).]

Behaviour

Character 31. Burrowed retreat of adults: (0) absent; (1) present. [Note. Specimens of some species may be found with retreats in the ground, but these are not scored “1” unless they have been actively dug by the spider.]

Character 32. Cohabitation of male with penultimate female prior to mating: (0) present; (1) absent.

Ecology

Character 33. Ability to inhabit outside rainforest: (0) absent; (1) present. [Note. *Corasoides motumae* inhabits both rainforest and wet sclerophyll and is scored (1).]

Character 34. Inability to inhabit below 1500 m in altitude. (0) absent; (1) present.

Of the 35 characters, 29 were based on morphology, two related to karyotype, two to behaviour and two were ecological. Of the 29 morphological characters, seven were based on female genitalia and eight on the male palpal organ while four of the remainder were at least partially gender dependent. Chromosomal characters and states were taken from Humphrey (in press). Behavioural and ecological characters and states are the author’s personal observations.

The following characters are often used in cladistical work on spiders but have not been used for the following reasons.

Colour and pattern. The colour of the head and anterior portion of the carapace provides an autapomorphy and quick and easy identification for *Corasoides motumae* sp. nov., it being the only species to be dark to black. It is the only colour pattern in *Corasoides*, other than banding in the legs, which does not overlap specifically. In general, colour and pattern are unreliable in *Corasoides*. A species often has a wide natural variation which may not be appreciated unless a large number of representatives, from throughout the distribution, is examined. This variation is also extended by age, sex, time from moulting and preservation conditions. This is very obvious in the abdominal pattern which, although typical of the genus, varies from pronounced to obscure. The smaller

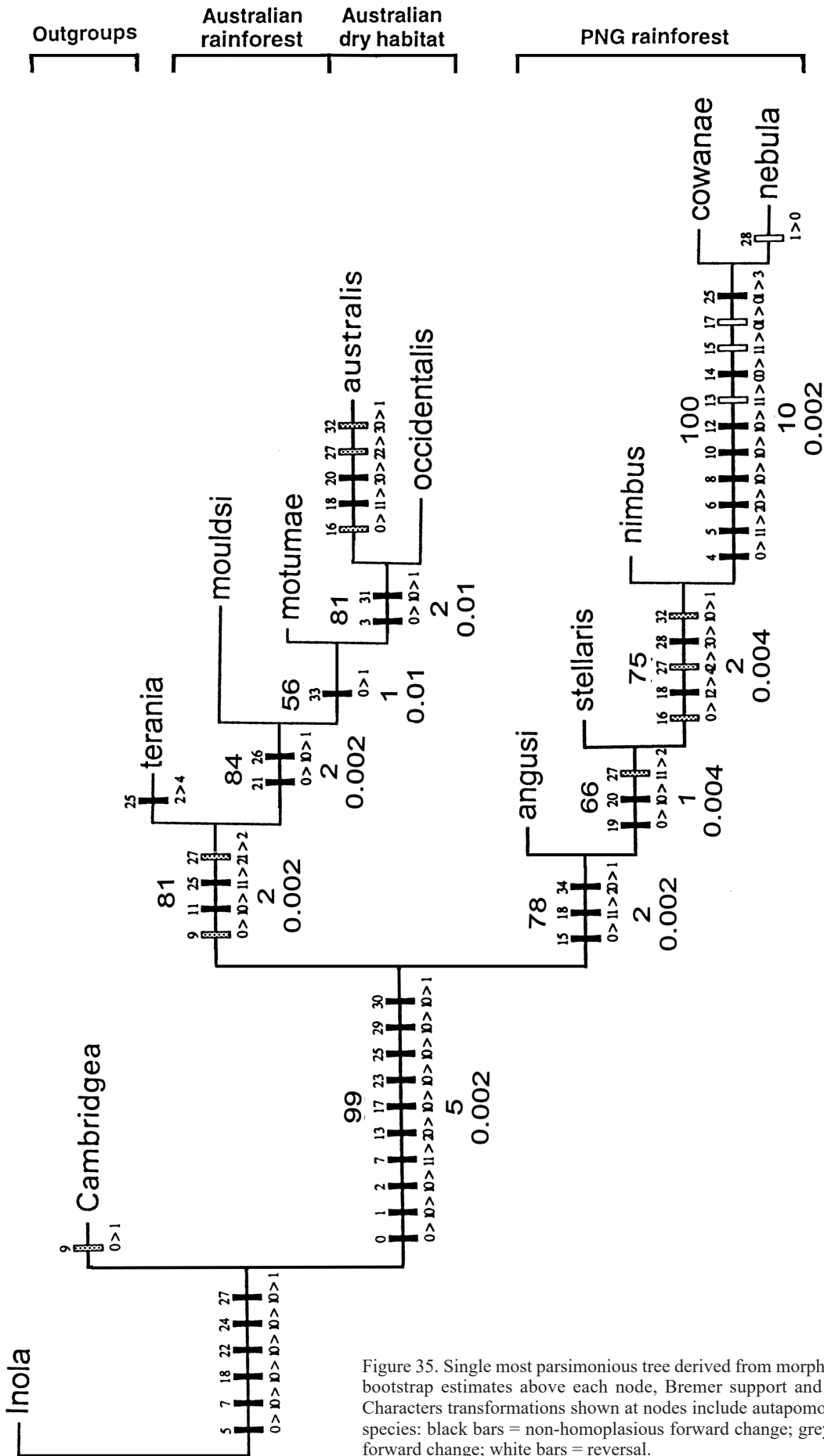

Figure 35. Single most parsimonious tree derived from morphological data, showing bootstrap estimates above each node, Bremer support and T-PTO scores below. Characters transformations shown at nodes include autapomorphies that help define species: black bars = non-homoplasious forward change; grey bars = homoplasious forward change; white bars = reversal.

Papua New Guinea species have a reduced pattern consisting of a double row of spots but again this can be faint or non-existent in preserved specimens.

Number of cheliceral teeth. There is insufficient variation between species in promarginal teeth and too much intraspecific variation causing overlap of states for retromarginal teeth. The number of cheliceral teeth sometimes varied from one side of a specimen to the other. However, the relative number of retromarginal teeth to promarginal teeth was useable, character 7.

Relationships of leg lengths to body lengths. Whether as absolute values or ratios, the states for leg length overlap between species. Leg length relationships are also dependent upon age, gender and degree of sexual development and legs are also subject to regeneration.

Number of trichobothria on legs and cymbium. The number and pattern of trichobothria on *Corasoides* is often difficult to ascertain and the numbers vary between specimens. Lehtinen (1978) argues that trichobothria number is allometric, related to leg size and gender.

Length of cymbium. The extreme length of the digitiform portion of the cymbium in *C. occidentalis* sp. nov. is characteristic for that species. However, intraspecific variation in other species of *Corasoides* (probably related to degree of secondary sexual development) negates the use of this character.

Results and discussion

Just a single most parsimonious tree was found, length 54, CI 81, RI 85 (Fig. 35) (all lengths, indices and tests were calculated with autapomorphies and uninformative characters removed).

This single most parsimonious tree consists of two clades that recognize the monophyly of both the Australian and Papua New Guinea species. In this respect it is in agreement with the Wagner consensus tree derived from allozyme data (Humphrey, 2015).

Testing

Bootstraps, Bremer support and TPTP values are shown in Fig. 35. All nodes have significant bootstrap support (greater than 70%, Hillis & Bull, 1993), except for two: that holding together *C. australis*, *C. occidentalis* sp. nov. and *C. motumae* sp. nov., and that holding together *C. stellaris* sp. nov., *C. nimbus* sp. nov., *C. cowanae* sp. nov. and *C. nebula* sp. nov.

Bremer support is the difference in length between the shortest tree with the branch and the shortest tree without it (Bremer, 1988). These test results are in agreement with the bootstrapping results, the weakest nodes having Bremer supports of only one while, the strongest have supports 10 and 5.

TPTP tests (Faith, 1991) were performed for each node three times; with all taxa randomized, with ingroup only randomized and without the outgroups (Trueman, 1995, 1996). The most conservative figures, those without the outgroups, from 500 replications, are given in Fig. 35. These results show that even the least supported nodes have good Bremer support greater than, or equal to, that from randomly permuted data 99% of the time.

Notable trends in characters

Chelicerae. The relative size and robustness of the chelicerae is an obvious feature of *Corasoides*. A trend can be seen throughout the genus, their length being particularly pronounced in the smaller Papua New Guinea species, *C. cowanae* sp. nov. and *C. nebula* sp. nov. The length of the chelicerae beyond the labium is to some extent dependent upon gender and also the degree of sexual development. In males it appears to be associated with relative cymbium and leg length.

Prominent bristle pairs on the chelicerae are present in genera in desids and have probably arisen independently several times. The presence of these bristles is a generic character for *Corasoides* but they have become secondarily reduced in two species, *C. australis* and *C. occidentalis* sp. nov. The absence of prominent cheliceral bristles in *Inola* is of no significance because of its distance from the ingroup. The absence of these bristles in *Cambridgea* is a separating character state from *Corasoides* within Porterinae.

Fangs. The degree of serration on the fangs varies between species, is most obvious in *Corasoides terania* sp. nov. and thus confirms its plesiomorphic state. The angular, chunky appearance of the fangs is more pronounced in *C. nebula* sp. nov. than in *C. cowanae* sp. nov. and there are also signs of it in *C. australis*. There is also variation in the length and slenderness between species of *Corasoides* with a general trend from very long, slender fangs in *C. terania* sp. nov., *C. mouldsi* sp. nov. and the large Papua New Guinea species, to relatively shorter fangs in *C. motumae* sp. nov., *C. occidentalis* sp. nov. and *C. australis*. Long, slender fangs are considered plesiomorphic for the group, the short fangs of *Inola* being irrelevant because of the distance of this outgroup from *Corasoides*.

Cheliceral teeth. The number of promarginal teeth in *Corasoides* shows little variation, while the number of retromarginal teeth varies within species and even from the left and right sides of the same individual. There is also intraspecific variation in the relative size of simple teeth and in the occurrence of semi-fused teeth. However, the relative number of retrolateral as opposed to prolateral is constant and without overlap (character 7).

Lehtinen (1978) cites instances of extreme lability of cheliceral armature even within species and concludes that type and distribution of cheliceral teeth is more significant than number. However, other than the presence of enlarged, distal retromarginal teeth (character 8) in the males of the smaller Papua New Guinea species, there is little variation in the type of cheliceral teeth in *Corasoides* and their distribution varies only slightly and then only as individual variation.

The presence of enlarged distal, retromarginal, cheliceral teeth in adult males supports the node holding the two small Papua New Guinea species together. The modification of teeth in *C. cowanae* sp. nov. and *C. nebula* sp. nov. would appear to be for sexual purposes, i.e. courtship or mating. As such, its degree of expression within the species would be expected to be associated with other male sexual characters, such as relative chelicera, cymbium and leg length. However, its absolute expression is constant for the males of both species. Enlarged cheliceral teeth are present in some other groups; in some Tetragnatha several retromarginal teeth are greatly elongated in males. This elongation also appears to be related to the degree of secondary sexual development.

Carapace. Length of cephalothorax supports the node holding together the two small Papua New Guinea species, *C. cowanae* sp. nov. and *C. nebula* sp. nov. Although cephalothorax length is a non-discrete character there is no overlap of the range of *C. cowanae* sp. nov. and *C. nebula* sp. nov. with the range of any other species.

Corasoides australis is generally intermediate in size between these two species and all other *Corasoides* but its size varies greatly across its distribution. Large specimens of *C. australis* from forest habitats may be larger than some specimens of rainforest species. Small specimens of *C. australis* are common in arid areas and particularly so for males. This probably indicates poor nourishment rather than genetic determinism although there is perhaps some suggestion that smaller size and a shorter development time could be advantageous for males in more hostile environments. In any case, assigning *C. australis* to an intermediate state would be cladistically uninformative.

Legs. The absence of banding on legs supports the Australian clade. Banding varies in the extent of its expression between species but its presence is constant in the Papua New Guinea clade. The banding of legs is absent in some species of *Cambridgea* but was present in the species used in this work.

Spines are present only on the patellae of the small Papua New Guinea species, *C. cowanae* sp. nov. and *C. nebula* sp. nov., and are more evident on the former, being present on the patellae of all legs. Number of spines on legs is usually related to leg length and overall body size (Lehtinen, 1978) and spine placement in *Corasoides* was often erratic and unreliable.

Spinnerets. The presence of a tail of pyriform spigots on the anterior lateral spinnerets is shared with four genera in Wheeler's Porterinae. The absence of the spigot tail on the anterior lateral spinnerets by the smaller Papua New Guinea species would be by secondary loss.

Internal female genitalia. The morphology of the insemination ducts is a very informative character in *Corasoides* and is the only character ordered in this cladistic analysis. The number of bends and turns appears to show a direct trend from simplicity in the outgroups to extreme complexity in the more derived species. However, attributes such as coiling and direction changes were autapomorphies.

The plesiomorphic state is of simple, straight insemination ducts. With increased length and complexity, they have become looped anterior to the spermathecae in Papua New Guinea species and looped between and around the spermathecae in Australian species.

Increased width of the initial portions of the insemination ducts appears to have been acquired within the Papua New Guinea clade.

Male characters. The presence of a bristled retroventral apophysis is unambiguous. It is absent in the Papua New Guinea species and in *C. terania* sp. nov. at the base of the Australian clade. It is doubtful whether the tuft of hairs between the ventral and retrolateral apophyses of *C. cowanae* sp. nov. or the row of hairs similarly placed in *C. nebula* sp. nov., are remnants of the retroventral apophysis. Its direction is known, as once lost, it would be extremely unlikely to be reacquired. It has been acquired, therefore, near the base of the Australian clade or alternatively (if the hairs in *C. cowanae* sp. nov. and *C. nebula* sp. nov. are homologous with this structure) has been lost twice, once at the base of the New Guinea clade and again by *C. terania* sp. nov.

The retrolateral apophysis in *Corasoides* may not be homologous with that in *Cambridgea* but its non-homology would make little difference in the cladistic analysis as there are several other characters separating the outgroups from the ingroup.

There are distinct retrolateral apophysis morphologies that are best described by the path followed by the apophysis from base to tip. These all form distinct groups except for *C. terania* sp. nov. whose retrolateral apophysis is very different from all the others. Complexity of the retrolateral apophysis is apomorphic in *Corasoides*.

The T-shape of the conductor is clearly apomorphic and has arisen in the Australian clade. The less developed condition in *C. mouldsi* sp. nov. is probably the intermediate state but in *C. occidentalis* sp. nov. could be a secondary reduction.

Embolus length is an important character that shows a trend from short at the base of the cladogram to long at the apices. The computer program assumes a change from state 1 to state 2 at the *C. stellaris* sp. nov. node where the scoring is "?".

Retrodorsal tibial apophysis on male palp is a unique structure that supports the *C. nimbus* clade. It is followed by a reversal, i.e. loss in *C. nebula* sp. nov.

Behaviour. Burrowing is an adaptation to dry conditions and this character state would be associated with character 33, habitat. As such, convergence must be considered. The grouping of *C. motumae* sp. nov., *C. occidentalis* sp. nov. and *C. australis* is thus weakly held.

Summary

This study indicates:

- 1 Separate monophyly of the Australian and Papua New Guinea species.
- 2 An asymmetrical Australian clade with *C. terania* sp. nov. as sister group to all the other Australian species and with *C. australis* and *C. occidentalis* sp. nov. strongly supported as sister species.
- 3 An asymmetrical Papua New Guinea clade with *C. angusi* sp. nov. sister group to all the other Papua New Guinea species and with *C. cowanae* sp. nov. and *C. nebula* sp. nov. strongly supported as sister species.
- 4 *Corasoides australis* has a wide distribution and varies morphologically.
- 5 The origin of *Corasoides* is in rainforest, probably in New Guinea. In Australia, some older *Corasoides* species have survived in remnant rainforest (*C. terania* sp. nov., *C. mouldsi* sp. nov.) while *C. motumae* sp. nov. (rainforest and wet sclerophyll) and then *C. occidentalis* sp. nov. and finally *C. australis* have adapted to a harsher, more arid environment.

ACKNOWLEDGMENTS. I am especially grateful to Dr H. A. Rose for considerable guidance and assistance over several years. He supported this project in many ways both practical and financial. I thank also Dr Mike Gray who patiently steered me through the world of arachnological taxonomy and kindly made facilities available to me at the Australian Museum. Also thanks go to Dr Max Moulds for assistance in field work, comments on the manuscript and guidance particularly on taxonomic matters. I am grateful to Dr John Trueman who led me through the intricacies of cladistics. Others whose advice I have appreciated include Prof. Chris Simon, the late Dr Courtenay Smithers, Dr David McAlpine, the late Dr Val Davies and Dr Barbara York Main. For assistance with electron microscopy thanks are due to Geoff Avern and Sue Lindsay of the Australian Museum and to

the staff of the Electron Microscope Unit, University of Sydney, especially Tony Romeo and Tom Joyce. Mike Gray kindly allowed me to use three of his electron micrographs (Figs 3a–c) and two prints (Figs 5a,b). Figure 5c is courtesy of David Knowles (ed. Robert Whyte). Martin Tio was constantly on call for computer assistance and Helen Smith was generous with her time and assistance, particularly in finalising this paper. I also thank Drs Shane McEvey and Max Moulds for kindly assembling the figures. The following people and institutions assisted with loans of material: Gordon Nishida (BPBM), Mark Harvey (WAM), Robert Raven (QMB), Craig Reid (QVM), Graham Milledge (MV, AM), David Hirst (SAM), Elizabeth Turner and Alison Green (TMAG), Queen Victoria Museum and Art Gallery (Launceston) and Mike Gray (AM). I am grateful to the following for assistance in field work or providing valuable specimens; Warrick Angus (who also tested my key to species), Max Moulds, Sally Cowan, Tina Goh, the late John (Jack) Humphrey, Fiona MacKillop, John Olive, Harley Rose, Helen Smith and Judy Thompson. For collecting permits I thank National Parks and Wildlife Services and Forestry Departments of Qld, NSW, Vic, SA and CALM, WA. The following provided valuable assistance in Papua New Guinea: OK Tedi Mining Ltd. (especially Marshall Lee), the Wau Ecology Institute, Wau, and Prue and Murray MacDonald formerly of Ambua Lodge, via Tari. Financial assistance is gratefully acknowledged from the Faculty of Agriculture, University of Sydney for a Norman Scott Noble Scholarship, the Linnean Society of NSW for a Joyce Vickery Research Award, the Australian Entomological Society for a student research award and EMU, University of Sydney, for a student grant.

References

- Bonnet, P. 1956. *Bibliographia Araneorum. Analyse méthodique de toute la littérature aranéologique jusqu'en 1939*. Toulouse: Douladoure.
- Bremer, K. 1988. The limits of amino-acid sequence data in angiosperm phylogenetic reconstruction. *Evolution* 42: 795–803. <https://doi.org/10.2307/2408870>
- Brignoli, P. M. 1983. *A catalogue of the Araneae Described Between 1940 and 1981*. Manchester, New Hampshire: Manchester University Press.
- Butler, L. S. G. 1929. Studies in Victorian spiders. *Proceedings of the Royal Society of Victoria* 42(1): 42–52.
- Butler, L. S. G. 1939. The Australian labyrinth spider. *Victorian Naturalist* 60: 186–189.
- Clerck, C. 1757. Svenska spindlar, uti sina hufvud-slägter indelte samt under några och sextio sarskildte arter beskrefne och med illuminerade figurer uplyste. Stockholmiae, 154 pp.
- Comstock, J. H. 1912. *The Spider Book*. Garden City, New York: Doubleday, Page and Co.
- Davies, V. T. 1988. Three new species of the spider genus *Stiphidion* (Araneae: Amaurobioidea: Stiphidiidae) from Australia. *Memoirs of the Queensland Museum* 25(2): 265–271.
- Faith, D. P. 1991. Classic permutation tests for monophyly and nonmonophyly. *Systematic Biology* 40: 366–375. <https://doi.org/10.1093/sysbio/40.3.366>
- Forster, R. R. 1967. The spiders of New Zealand Part I. *Otago Museum Bulletin* 1: 1–180.
- Forster, R. R., and C. L. Wilton. 1968. The spiders of New Zealand Part II. *Otago Museum Bulletin* 2: 1–123.
- Forster, R. R., and C. L. Wilton. 1973. The spiders of New Zealand. Part IV. *Otago Museum Bulletin* 4: 1–309.
- Gray, M. R. 1982. A revision of the spider genus *Baiami* Lehtinen (Araneae, Amaurobioidea). *Records of the Australian Museum* 33(18): 779–802 (1981). [Cover date 31 October 1981, date published 31 January 1982]. <https://doi.org/10.3853/j.0067-1975.33.1981.197>
- Griswold, C. E., J. A. Coddington, N. I. Platnick, and R. R. Forster. 1999. Towards a phylogeny of the Entelegyne spiders (Araneae, Araneomorphae, Entelegynae). *Journal of Arachnology* 27: 53–63.
- Hillis, D. M., and J. J. Bull. 1993. An empirical test of bootstrapping as a method of assessing confidence in phylogenetic analysis. *Systematic Zoology* 42: 182–192. <https://doi.org/10.1093/sysbio/42.2.182>
- Humphrey, M. 2015. An allozyme electrophoretic study of populations of spiders of the genus *Corasoides* (Araneae: Stiphidiidae) from Australia and Papua New Guinea. *Proceedings of the Linnean Society of New South Wales* 137: 71–83.
- Koch, L. 1872. *Die Arrachniden Australiens, nach der Natur beschrieben Australiens und abgebildet* 1: 105–368.
- Lamy, E. 1902. Recherches anatomiques sur les trachées des Araignées. *Annales des Sciences Naturelles Zoologie et Biologie Animale*(A)15: 149–280.
- Lehtinen, P. T. 1967. Classification of the cribellate spiders and some allied families, with notes on the evolution of the suborder Araneomorpha. *Annales Zoologici Fennici* 4: 199–468.
- Lehtinen, P. T. 1978. Definition and limitation of supraspecific taxa in spiders. *Symposia of the Zoological Society of London* 42: 255–271.
- Main, B. Y. 1982. Some geographic considerations of families of spiders occurring in New Guinea. In *Monographiae Biologicae*, ed. J. L. Gressitt, pp. 583–602, vol. 42, no. 4. The Hague: W. Junk.
- Merrill, E. 2014. Revision and phylogenetic analysis of the spider genus *Porteria* (Araneae, Desidae). San Francisco State University, unpublished thesis.
- Neave, S. A. 1939. *Nomenclator zoologicus. A List of the Names of Genera and Subgenera in Zoology from the Tenth Edition of Linnaeus 1758 to the End of 1935*. Vol. 1, pp. v–xiv, 1–957. Regent's Park, London: Zoological Society of London.
- Nixon, K. C. 1992. *Clados version 1.2*. Computer program and reference manual. Privately published by the author.
- Platnick, N. I. 1993. *Advances in Spider Taxonomy 1988–1991 with Synonymies and Transfers 1940–1980*. New York: New York Entomological Society.
- Platnick, N. I. 1997. *Advances in Spider Taxonomy 1992–1995 with Redescriptions 1940–1980*. 976 pp. New York: New York Entomological Society and American Museum of Natural History.
- Rainbow, W. J. 1897. Descriptions of some new Araneidae of New South Wales, No. 8. *Proceedings of the Linnean Society of New South Wales* 23(3): 514–553, pls 17–18.
- Roewer, C. F. 1954. *Katalog der Araneae von 1758 bis 1940*. Vol. 2a, pp. 1–923. Bruxelles: Institute Royal des Sciences Naturelles de Belgique.
- Swofford, D. L. 1998. *PAUP* 4.0. Phylogenetic analysis using parsimony*. Beta version 4.0b2. Smithsonian Institute.
- Thorntwaite, C. W. 1948. An approach toward a rational classification of climate. *The Geographical Review* 38: 55–94. <https://doi.org/10.2307/210739>
- Tio, M., and M. Humphrey. 2010. Description of a new species of *Inola* Davies (Araneae: Pisauridae), the male of *I. subtilis* Davies and notes on their chromosomes. *Proceedings of the Linnean Society of New South Wales* 131: 37–42.
- Trueman, J. 1995. Sponges, plants and T-PTP. *Systematic Biology* 44: 429–434. <https://doi.org/10.1093/sysbio/44.3.429>
- Trueman, J. 1996. Permutation tests and outgroups. *Cladistics* 12: 253–261.
- Wheeler, W. C. *et al.* 2016. The spider tree of life: phylogeny of Araneae based on target-gene analyses from an extensive taxon sampling. [First published Wiley online library, 12 December 2016, pp. 1–43]. <https://doi.org/10.1111/cla.12182>