

# AUSTRALIAN MUSEUM SCIENTIFIC PUBLICATIONS

McAlpine, David K., 1968. The genus *Cairnsimyia* Malloch (Diptera, Heleomyzidae, Rhinotorini). *Records of the Australian Museum* 27(12): 263–283. [29 July 1968].

doi:10.3853/j.0067-1975.27.1968.446

ISSN 0067-1975

Published by the Australian Museum, Sydney

nature culture **discover**

Australian Museum science is freely accessible online at  
[www.australianmuseum.net.au/publications/](http://www.australianmuseum.net.au/publications/)  
6 College Street, Sydney NSW 2010, Australia



# THE GENUS *CAIRNSIMYIA* MALLOCH (Diptera, Heleomyzidae, Rhinotorini)

By DAVID K. McALPINE

The Australian Museum, Sydney

Figures 1-26

Manuscript received, 13th September, 1967

## Synopsis

The known species of the genus *Cairnsimyia*, all of which occur in Australia and New Guinea (including Papua and West Irian), are described and a key is given for their identification. Six of the nine species are described as new. The larva of one species is also described. The family Rhinotoridae is reduced to a tribe of the family Heleomyzidae.

## Introduction

The subfamily Rhinotorinae was proposed by Williston (1896) within the family Ropalomeridae (often incorrectly spelled Rhopalomeridae) and was elevated to family rank by Hendel (1916). Most authors, however, continued to regard it as a subfamily of the Ropalomeridae until recently, when Brues, Melander, and Carpenter (1954), Wheeler (1954), and Steyskal (1957) have advocated family status for the Rhinotoridae. Hennig (1948) placed this group in the Lauxaniidae but later (1958) regarded it as a distinct family related to the Heleomyzidae, pointing out the numerous differences separating it from the Ropalomeridae.

The author (McAlpine, 1958) referred the Australian genus *Cairnsimyia* Malloch, originally described as a heleomyzid, to the Rhinotoridae, and almost simultaneously Hennig (1958) commented on its similarity to that family.

Faunal treatises and texts including keys to families of Diptera almost invariably exclude the Rhinotoridae as a distinct family, though its members cannot be run to Ropalomeridae in keys. Brues, Melander, and Carpenter (1954) include Rhinotoridae at two points in their key to the families of Diptera. None of the species will run to the first point in their key, though most of the neotropical ones may be run to the second. The separation of the Trixoscelidae from them is very imperfect, as in many of these the subcosta is less developed than in the Rhinotoridae.

This group is here reduced to a tribe, the Rhinotorini, within the family Heleomyzidae, for reasons which are explained below.

Some notable characters of the Rhinotorini, which illustrate its close relationship to other Heleomyzidae, are as follows: vibrissae are present, though the elongation of the face may make the position of the vibrissal angle obscure; convergent postvertical bristles occur in *Rhinotoroides* and in some species of *Cairnsimyia*; preapical tibial bristles are often present, though short, in *Cairnsimyia*; the costa is broken near the termination of the subcosta.

Rec. Aust. Mus., **27**, page 263.

### Location of Specimens

The following abbreviations are used below to indicate the collections in which material is located:

AM	Australian Museum, Sydney.
BM	British Museum (Natural History), London.
CSIRO	Australian National Insect Collection, Commonwealth Scientific and Industrial Research Organization, Canberra.
DEI	Deutsches Entomologisches Institut, Eberswalde, East Germany.
NMV	National Museum of Victoria, Melbourne.
QM	Queensland Museum, Brisbane.
SAM	South Australian Museum, Adelaide.
SPHTM	School of Public Health and Tropical Medicine, University of Sydney.
UQ	Entomology Department collection, University of Queensland, Saint Lucia, Brisbane.
USNM	United States National Museum, Washington, D.C.

### Acknowledgements

Miss Kathleen English, who has added much to the knowledge of Australian dipterous larvae, is responsible for discovering the larvae of *Cairnsimyia* here described. Mr J. C. Deeming, formerly of the British Museum (Natural History), provided information on the types of Walker's two species, thus preventing the publication of unnecessary synonyms. Dr G. Morge and Dr C. W. Sabrosky provided information on specimens in the Deutsches Entomologisches Institut and United States National Museum respectively, and Mr B. H. Cogan and Mr K. G. V. Smith supplied information regarding labels on specimens in the British Museum (Natural History).

### Family HELEOMYZIDAE Loew

#### Tribe **Rhinotorini** Williston new status

Vertex of head excavated, cheeks very broad; postverticals often small or absent; orbits usually rather short, with one or two reclinate fronto-orbital bristles; antennae porrect, with compact, rounded third segment; distal section of proboscis elongate, with reduced labella. Dorsocentrals 1 or 2; propleural small or absent; mesopleuron bare or haired, sometimes with weak posterior bristles. Preapical tibial bristles very short or absent. Costa without major spines, sometimes variably weakened beyond hm; Sc approximated to vein 1, sometimes obsolete at extreme apex; submarginal cell ( $R_3$ ) usually narrower than first posterior cell ( $R_5$ ) at apex; vein 6 not reaching margin. Male abdomen with tergite 6 greatly reduced.

The above characters distinguish the tribe from other groups within the Heleomyzidae. The relationship to the genera *Anastomyza* Malloch and *Apophoneura* Malloch is so close that the author has considered including these in the Rhinotorini. They are, however, distinguished by the following characters: vertex not excavated; costa with prominent spaced spines on anterior surface. In the Rhinotorini, as in most other heleomyzids, there is a series of close set thick black spinules on anterior surface of costa, but only in *Cairnsimyia cavifrons*, among the species of this tribe seen by the author, is there an additional anterior series, consisting of a few small spinules at irregular intervals beyond end of subcosta.

The author maintains that the tribe Rhinotorini is an extreme development of that branch of the Heleomyzidae which includes *Anastomyza* and *Apophoneura*. A study of the species of the genus *Apophoneura* reveals that most of the peculiar characters of the genus *Rhinotora* are foreshadowed, often in a less exaggerated form, in all or

some of these species. The author presents a list of these *Rhinotora*-like characters which he has observed in the genus *Apophoneura* (many of which also occur in species of *Anastomyza*).

1. Slight tendency of vertex of head to become depressed and eyes to bulge posteriorly (most noticeable in *A. exquisita* Malloch).
2. Cheeks widened in comparison with most other Heleomyzidae.
3. A strong bristle near middle of cheek, usually in addition to a posterior cheek bristle corresponding to that of *Diplogeomyza*, *Suillia*, etc.
4. Distal section of proboscis somewhat elongate, with shortened labella.
5. Arista tending to be inserted at or beyond middle of third antennal segment (e.g., *A. superba* Malloch).
6. Dorsocentral bristles reduced to two pairs.
7. Scutellum somewhat elongate (in *A. exquisita* Malloch and *A. superba* Malloch).
8. Short spinescent bristles present on ventral surface of fore femur (in males of *A. exquisita* Malloch and *A. punctipennis* Malloch).
9. Preapical tibial bristles much reduced or indistinct (especially so in *A. recurrens* Malloch).
10. Spaced anterior costal spines may be scarcely longer than anterodorsal series of coastal spinules (in *A. picta* Malloch).
11. Crossveins present between costa and vein 2 (in *A. exquisita* Malloch, *picta* Malloch, *punctipennis* Malloch, and *superba* Malloch).
12. Cerci of males fused.

Wheeler (1954) has defined the Rhinotoridae as having the subcosta complete, from his examination of specimens of *Rhinotora diversa* Giglio-Tos. His figure, however, shows the subcosta not quite reaching the costa. In the four neotropical species available to the author—*Rhinotora pluricellata* Schiner, *R. diversa* Giglio-Tos, *Rhinotoroides bifurcata* Lopes, and *Neorhinotora mutica* (Schiner)—the subcosta is obsolete or indistinctly pigmented for a short distance before reaching the costa.

The tribe occurs in the warmer parts of the Neotropical Region (genera *Rhinotora*, *Rhinotoroides*, and *Neorhinotora*) and in New Guinea and eastern Australia as far west as South Australia and including Tasmania (genus *Cairnsimyia*). The neotropical genera are more closely related to one another than to *Cairnsimyia* and together they undoubtedly form a separate monophyletic unit. Evidence of this is provided in the following table:

#### Characters of Neotropical and Australasian Genera

Neotropical	Australasian
An outstanding isolated postgenal bristle	No postgenal bristle, but a series of marginal cheek bristles present
2 dorsocentral bristles	1 dorsocentral bristle
Presutural bristle strongly developed	Presutural bristle absent or minute
Scutellum bare or minutely pubescent	Scutellum setulose
Subcosta apically indistinct	Subcosta distinct throughout
Cerci of ♂ fused and joined laterally to edges of epandrium	Cerci of ♂ free or fused but not joined laterally to epandrium

### Morphology of the Protandrium

The protandrium consists of those segments of the abdomen of a male fly which lie between the preabdomen (usually segments 1-5 in the Schizophora) and the genital segment or hypopygium (segment 9). Irregularities of the sclerites of this region occur in the higher Diptera (Cyclorrhapha) as a result of the rotation of the genital segment through a complete circle. This may result in a simple spiral displacement of tergites and sternites of the protandrium as seen in some Coelopidae. More often there is reduction or fusion of the sclerites, which, in extreme cases, tends to restore external symmetry.

The study of the rhinotorine protandrium raises several interesting problems if approached from the orthodox method of seeking to homologize its visible parts. In attempting to identify these parts the author has made the three following observations:

1. Some structures are clearly secondary sclerotizations of the cuticle and not homologous with tergites or sternites.
2. Whilst individual spiracles are presumably homologous with those from the sixth and seventh pairs of less specialized Diptera, there is in some cases no clear existing evidence of their identity.
3. The existing sclerites, even when distinguished by discontinuity or visible lines of fusion, are often not readily interpreted as exact homologues of tergites or sternites. It is probable that these parts became partly fused or otherwise modified so far back in evolutionary history as to have lost their exact identity. The nomenclature here used for the sclerites should be taken as giving only an approximate indication of their probable homologies.

The protandria of three genera have been investigated in the present study: *Neorhinotora* [represented by *N. mutica* (Schiner), fig. 9]; *Rhinotora* (represented by *R. pluricellata* Schiner, fig. 10); *Cairnsimyia* (several species examined, see fig. 11). Steyskal (1957) has described and figured the protandrium of *Rhinotora diversa* Giglio-Tos.

In illustrating the protandria I have used a method devised by Steyskal (1957 and elsewhere). They are shown as if split along the median ventral line and then spread flat. The broken lines at the sides of the diagrams represent the median ventral line, and that in the centre the median dorsal line.

In all genera tergite 6 is reduced and more or less fused with the dorsally placed sternite 8. Sternites 6 and 7 are displaced to the left side and connected to sternite 8, which is always well developed. Apart from these general similarities, the conformation of the sclerites is very diverse.

In *Neorhinotora* tergite 6 is well defined and joined antero-dorsally to sternite 8. The sixth left spiracle is contained within its left lateral limits. A partly detached piece on its right lateral extremity contains the sixth and seventh right spiracles, each of which may be identified from the fact that one lies posteriorly to the other. A narrow secondary sclerotized band runs completely round the ventral surface and is joined to the anterolateral margin of tergite 6 on each side. Sternites 6 and 7 are less clearly joined to the dorsal complex than in other forms of the tribe. Sternite 7 is joined to sternite 8 by a narrow band upon which the seventh left spiracle is situated. In the degree of independence of tergite 6 this might be considered to be the least specialized of the forms here described. On the other hand, it possesses the symmetrically formed secondary ventral band of segment 6, an extraordinarily specialized structure only known in neotropical species of Rhinotorini.

The protandrium of *Rhinotora pluricellata* is similar in some respects to that of *Neorhinotora* but is more specialized and more nearly approaches a symmetrical condition. Tergite 6 has become largely desclerotized in the mid-dorsal region and what remains of it is fused with sternite 8. However, the secondary ventral band is well developed, extending downwards from each side and continuing around the ventral surface. Sternites 6 and 7 are weakly developed on the left side and merge with sternite 8 at their dorsal extremities. The large sternite 8 contains the spiracles of the sixth and seventh pairs, and, as these are situated one above the other, it is not possible to identify the spiracles individually.

In *Cairnsimyia* the structure suggests evolution along somewhat different lines. The existing sclerites are fused into a single highly asymmetrical mass, the greater part of which is situated on the dorsal surface. In *C. robusta* this includes tergite 6, whilst in *C. uniseta* tergite 6 is free. Tergite 6 is displaced further to the right than usual, and in *C. robusta* is seen to include 2 spiracles on the right side and 1 on the left. Sternite 6 occupies a lateroventral position and sternite 7 is laterally placed, serving to connect sternite 6 to the dorsal sternite 8. Along the anterior margin of sternites 6 and 7 there is a heavily sclerotized strip, which may have some relationship to the ventral band of the neotropical forms, but differs in being asymmetrical, confined to the left side, and fused to the sternites for its full length.

#### Genus **Cairnsimyia** Malloch

*Cairnsimyia* Malloch, 1931: 294.

Head strongly excavated on vertex, the ocellar and postocellar regions slightly convex within the excavation; cheeks broad; face concave in profile, protuberant on middle of lower margin, extended laterally below cheeks; prelabrum prominent; fronto-orbital bristles one or two, rather short; postverticals often small or absent, convergent when present; vibrissae and usually some long cheek bristles present; proboscis slender with small labella. Antenna porrect, with short, inconspicuous first segment; second segment short, truncate, third segment rounded, tumid; arista long, with variable minute pubescence.

Thorax broad; mesoscutum extensively setulose; disc of scutellum setulose; presutural bristle minute or absent; one dorsocentral; four strong scutellar; propleural weak or replaced by fine hairs; mesopleuron haired, sometimes one or more of the posterior hairs developed into a bristle; two to four sternopleurals and some fine hairs on upper part of sternopleuron; prosternum with one or more pairs of hairs or setulae. Legs rather short and stout; preapical dorsal tibial bristles very small or absent. Wings extensively patterned with brown spots, without supernumerary crossveins; costa broken only at end of subcosta, with spaced spines short and weak or absent, a series of closely placed black spinules on its dorsal surface; subcosta strongly developed but very close to vein 1 throughout, sometimes fused with vein 1 at extreme tip; vein 2 long; vein 4 strongly angled at junction with anterior crossvein; second basal and anal cells complete; anal crossvein curved; vein 6 not nearly reaching wing margin.

Abdomen short and broad. Male postabdomen with tergite 6 narrow, displaced towards right side, more or less fused with sternite 8 or quite free; sternite 6 ventral, largely contained in an invagination of the cuticle above sternite 5, joined to the lateral sternite 7 which in turn is joined to the dorsal sternite 8; one pair of articulated surstyli; cerci separate or fused.

Type species: *Cairnsimyia cavifrons* Malloch.

Key to Species of *Cairnsimyia*

1. Ocellar and humeral bristles minute or absent; prelabrum with median process or prominence; Papua ..... *aroana* nov.  
 Ocellar and humeral bristles long and strong; prelabrum without process or distinct prominence ..... 2
2. Two fronto-orbitals; all femora with thickened spine-like ventral bristles; propleuron without erect hairs near centre; in male, anterior paramere (pregonite) large with 1 or 2 terminal spines .... 3  
 One fronto-orbital; femora without thickened bristles or spines; propleuron with fine erect hairs near centre; in male, anterior paramere undeveloped ..... 5
3. Two or three brown spots in costal cell; surstylus of male somewhat narrowed basally, the produced anterior distal angle not recurved; female postabdominal segments normal, telescopic, without spine-like marginal bristles on sternite 5; Queensland, New South Wales, Victoria, Tasmania and South Australia ..... *robusta* (Walker)  
 No spots in costal cell; surstylus and female postabdomen variable ..... 4
4. Wing with numerous distinct brown spots; surstylus very attenuated basally, the produced anterior distal angle recurved; female abdomen with all segments behind the fourth forming the lining of a gaping cup-shaped cavity; Queensland ..... *excavata* nov.  
 Wing with very indistinct pale-grey spots; surstylus not much attenuated basally, broadened and elbowed before middle, with slender distal part projecting forwards, female postabdomen normal, folding telescopically; New South Wales ..... *sydneyensis* nov.
5. Prescutellar acrostichals absent; third antennal segment horizontally ovoid; arista variable ..... 6  
 Prescutellar acrostichals present; third antennal segment not longer than high, almost circular; arista not thickened, brown ..... 7
6. Arista somewhat thickened, with dense white pubescence; West New Guinea ..... *inscripta* (Walker)  
 Arista slender with very inconspicuous pubescence; New Guinea ..... *crosskeyi* nov.
7. Mesopleuron with one or more long setulae on extreme posterior margin; ocellar spot not extending in front of ocellar triangle; veins conspicuously paler in region of basal cells; Queensland, New South Wales ..... *cavifrons* Malloch  
 Mesopleuron without prominent setulae on posterior margin; a large blackish patch surrounding ocelli; wing veins only paler at extreme base ..... 8
8. Postverticals well developed, about as long as the fronto-orbitals; surstyli obliquely oval, about twice as long as wide; Queensland, New South Wales ..... *verticalis* nov.  
 Postverticals very small; surstyli spatulate, about three times as long as maximum width; Queensland, New South Wales, Victoria ..... *uniseta* nov.

**Cairnsimyia robusta** (Walker) new comb.

(Figs 1, 11, 14, 22-26)

*Heteromyza robusta* Walker, 1853: 403.

This species is closely related to *C. excavata* (described below) but differs in the black sternopleural bristles, spots in the costal cell and structure of male and female postabdomens.

♂ postabdomen with surstylus stout, curved, slightly narrowed basally, truncate distally with anterior angle prominent and posterior angle rounded off; hypandrium with a rounded lateral lobe, at the base of which is a series of horizontal grooves; a short, setulose process just in front of lateral lobe; anterior paramere prominent, elongate, with three short, thick setulae on inner surface at base and two terminal, claw-like, finely acuminate spines; posterior paramere small, concealed from the side by lateral section of hypandrium, with about 5 fine terminal spines; aedeagus with terminal section shorter than in *C. excavata*; cerci completely fused into a small, conical, haired process.

♀ postabdomen of the normal telescopic form; no spines on sternite 5; cerci slender.

Dimensions: total length, ♂ 3.6-5.6 mm, ♀ 3.9-4.7 mm; length of thorax, ♂ 1.8-2.3 mm, ♀ 1.9-2.4 mm; length of wing, ♂ 3.5-4.8 mm, ♀ 3.5-5.0 mm. Reared specimens are not included in these measurements as most are abnormally small.

Last instar larva (fig. 22) elongate-fusiform, tapered posteriorly, the terminal segment produced into a short siphon; surface of cuticle smooth. Anterior spiracle (fig. 25) with numerous short branches arising from the elongate central axis; posterior spiracles (fig. 26) on separate short tubercles at end of siphon, each spiracle with 3 broad oval openings containing short lamellae just within the aperture, surrounded by 4 groups of flattened hydrophobe hairs, some of which are branched. Anterior margins of abdominal segments 2-7 with well developed creeping pads armed with numerous short, stout, slightly hooked spines; abdominal segment 1 and the 3 thoracic segments with a few rows of spines on anterior margins of their ventral surfaces, there being only 3 rows of spines on prothorax (fig. 24); anal region without a spinose pad. Head region (fig. 24) completely surrounded by a fringe of slender, soft appendages which are long, tentacle-like, and particularly numerous at sides; anterior part of head region with the usual 2 pairs of papillae, the upper one being that considered by many dipterists to represent the antennae; an additional 2 pairs of sensory papillae at each side of atrial opening, and a pair of simple process at posterior margin of this area; a pair of tooth-like processes between these simple papillae; a pair of plates on each side of atrial opening, which bear serrated transverse ridges; a pair of unpigmented but heavily ridged, sclerotized plates on posterior margin of atrial opening near base of mouth-hooks, which may represent the dentate sclerites. Cephalopharyngeal skeleton as shown in fig. 23, with pigment distributed as in that figure; mouth hooks simple; a pair of small rod-like sclerites between and below anterior arms of hypostomal sclerite; a small dorsal plate above hypostomal sclerite; floor of pharyngeal sclerite with longitudinal folds.

Distribution: southeastern Queensland; eastern New South Wales; Victoria; coastal South Australia; Tasmania.

Material examined (adults)—Queensland: Brisbane, October, 1928 (3 ♂, 3 ♀, UQ), F. A. Perkins; Caloundra, August, 1929 (1 ♀, UQ), F. A. Perkins. New South Wales and Australian Capital Territory: Kurrajong, October, 1958 (1 ♂,



AM), D. K. McAlpine; Hornsby, near Sydney, October, 1957 (1 ♂, 3 ♀, SPHTM), D. J. Lee; Roseville, near Sydney, reared, February, July, August, 1958-1962 (11 ♂, 12 ♀, AM, 2 ♂, 2 ♀, USNM), K. English; Vacluse, near Sydney, January, 1963 (1 ♂, AM), C. V. Nathan; Gundamaian, Royal National Park, January, 1926 (1 ♂, CSIRO), I. M. Mackerras; Waterfall, Royal National Park, April, 1925 (1 ♀, CSIRO), I. M. Mackerras; Black Mountain, Canberra, February, 1960 (1 ♀, CSIRO), I. F. B. Common. Victoria: Warburton, January, 1924 (3 ♂, SPHTM), F. E. Wilson; Mordialloc, January, 1918 (♂, ♀ in copula, NMV), no collector's name. South Australia: Sleaford Bay, near Port Lincoln, March, 1961 (1 ♀, CSIRO), J. Casanova. Tasmania: Launceston, January, 1914 (1 ♀, SAM); Mangalore, near Hobart, January, 1913 (1 ♂, 1 ♀, BM), A. White.

Holotype: Van Dieman's Land (BM), re-examined by J. Deeming.

Habitat: dry sclerophyll forest, partly cleared country, and suburban gardens. The larvae were found by Miss K. English in tunnels made by cerambycid larvae in a fig tree in her garden. Pupation took place within the tunnel near the entrance.

### **Cairnsimyia sydneyensis** sp. nov.

(Figs 2, 13, 16)

♂ ♀: head yellowish-buff; frons, except the orbits and triangle, brown; a brown patch extending both in front of and behind ocelli; brown spots at bases of fronto-orbital and vertical bristles; all cheek hairs pale. Antenna yellow-brown, darker above. Prelabrum and palpi light yellow-brown. Thorax, light reddish-brown; mesoscutum with 4 somewhat ill-defined longitudinal greyish-buff bands of the same colour behind suture, these bands tending to merge in parts, and a narrow median such band posteriorly; pleura with a longitudinal pale-buff band from centre of propleuron to upper part of pteropleuron, and less distinct bands from lower part of propleuron to metathoracic spiracle and on upper part of sternopleuron; hairs on mesopleuron pale except for a few brown ones near posterior margin; hairs on sternopleuron all pale. Legs light yellowish, the femora, especially the hind ones, variably suffused with yellowish-brown; tibiae with a brown band before middle and one near distal end which may be narrow and subterminal or broader and reaching apex of tibia. Wing (fig. 2) with spots that are pale greyish, rather indistinct, and fewer than in *C. excavata*, *robusta*, and *uniseta*; no spots in costal cell. Abdomen yellowish-brown.

General structure very similar to that of *C. excavata* (see below). Fronto-orbital bristles shorter and weaker than in that species, the anterior one sometimes duplicated.

Sternopleural bristles usually 1 or 2, unpigmented. Femora with well developed anteroventral and posteroventral series of spines, except for the anteroventral series on fore femur which is much reduced; a short preapical dorsal bristle sometimes distinguishable on fore tibia. Wing with submarginal cell not much narrower than marginal cell for most of its length.

♂: postabdomen with surstylus strongly bent forward before middle, tumid posteriorly at the bend, distal part directed forward, more slender than basal part; anterior paramere large and prominent, directed outwards and forwards, with some long setulae anteriorly and shorter ones towards base posteriorly, and with a large horizontally flattened articulated terminal claw; posterior parameres very small and scarcely visible without dissection; aedeagus as in fig. 16B; cerci fused, setulose.

♀: postabdomen folding telescopically; segment 5 large and exerted; sternite 5 with some short black spines near posterior margin; cerci slender, haired.

Dimensions: total length, ♂ 5.4 mm, ♀ 5.4-5.8 mm; length of thorax ♂ 2.5-2.6 mm, ♀ 2.6-3.0 mm; length of wing, ♂ 5.4-5.5 mm, ♀ 5.7-6.2 mm.

Distribution: New South Wales—central coast district.

Material examined: Sydney, 18th October, 1938 (holotype ♂, paratypes, 3 ♀, CSIRO, 1 ♂, 1 ♀, AM), A. D. Gill; Gundamaian, Royal National Park, January, 1926 (paratype ♀, CSIRO), A. J. Nicholson.

**Cairnsimyia excavata** sp. nov.

(Figs 3, 15)

♂ ♀: head brownish-grey; cheeks yellowish; frons, except the orbits and frontal triangle, brown; a brown blotch enclosing the ocelli and extending well behind them; fronto-orbital bristles and sometimes also the inner vertical bristle arising from brown spots; all cheek hairs pale. Antennae yellow-brown, darker above; prelabrum brown; palpi yellowish. Mesoscutum and scutellum grey with rusty-brown markings, a darker brown mark on each side above humeral callus and another just above wing base; scutellum pale yellowish at apex; pleura reddish-brown, with thin greyish dusting on most of surface, a conspicuous creamy-white band extending from middle of propleuron to about middle of pteropleuron, and a blotch of similar colour on lower part of propleuron; mesopleuron with fine pale hairs, sometimes a few darker ones on posterior margin. Legs yellow-brown; tibiae each with a sub-basal and subapical darker brown band. Wing (fig. 3) with numerous greyish-brown, mostly rounded spots, absent in costal cell. Abdomen rusty-brown, the tergites more yellowish towards their distal margins and greyish towards lateral margins.

Head with vertex more broadly and shallowly excavated than in *C. cavifrons* and *C. uniseta*; two fronto-orbitals, the anterior one slightly shorter; ocellars long, proclinate about twice as widely separated from each other as are the two posterior ocelli; postverticals absent; usually only one short brown or black cheek bristle behind vibrissa; third antennal segment as high as long; arista appearing bare with normal magnification, but with sparse minute hairs visible at a magnification of x200.

Humeral bristle well developed; prescutellar acrostichal absent; scutellum flattened, broadly rounded, the bristles evenly spaced; propleuron without long hairs near centre but with very short, dense pubescence in this region; propleural bristle reduced to a weak pale hair; sternopleural bristles usually 3, often unpigmented in male. Fore femur with series of strong posteroventral spines and weaker anteroventral spines; middle and hind femora with strong anteroventral spines and usually some weaker posteroventral spines; preapical tibial bristles not distinguishable. Wings rather narrow; submarginal cell much narrower than marginal cell for most of its length.

♂: postabdomen with surstylus much narrowed basally, expanded and curved forwards distally making the anterior margin deeply concave; anterior paramere large, and very prominent, elongate, with a long, obtuse terminal black spine, and two or three hairs anteriorly, one of which is long and curved; posterior paramere small with a few fine terminal spines; aedeagus slender basally with the usual swollen sclerotized terminal section; cerci joined ventrally, with numerous rather long hairs.

♀: postabdomen greatly modified, not telescopic; all segments behind segment 4 forming the lining of a large cavity, with what appears to be tergite 5 divided into a pair of oval sclerites; cerci not apparent.

Dimensions: total length, ♂ 4.0–4.4 mm, ♀ 4.6–5.0 mm; length of thorax, ♂ 1.9–2.1 mm, ♀ 2.2–2.3 mm; length of wing, ♂ 4.1–4.5 mm, ♀ 4.8–5.0 mm.

Distribution: southern Queensland—tablelands.

Material examined: Stanthorpe, 26th August, 1925 (holotype ♂, QM, paratypes, 1 ♂, 1 ♀, AM, 2 ♂, 2 ♀, UQ), F. A. Perkins.

**Cairnsimyia verticalis** sp. nov.

(Figs 4, 17)

♂ ♀ : agreeing with the description of *C. uniseta* in all characters except the length of the postverticals and the structure of the male terminalia.

Postverticals well developed, about as long as fronto-orbital bristles, convergent or crossed.

♂ with abdominal tergite 6 reduced and scarcely visible on the left side; both spiracles of sixth and seventh pairs present. Surstylus almost oval, less than twice as long as maximum width, anterior margin more convex than posterior margin, the apex with numerous, dense, short spines, mainly on inner surface, elsewhere with fairly long setulae. Parameres short, bispinose apically; no additional processes on hypandrium. Cerci small, short-haired, fused.

♀ with normal terminal segments and slender cerci.

Dimensions: total length, ♂ 3.9–4.3 mm, ♀ 4.5–4.8 mm; length of thorax, ♂ 1.8–2.2 mm, ♀ 2.3–2.4 mm; length of wing, ♂ 3.6–4.7 mm, ♀ 4.6–5.0 mm.

Distribution: southern Queensland; northern New South Wales.

Material examined—Queensland: Eidsvold, no date (holotype ♀, paratype ♀ SPHTM), T. L. Bancroft, (paratypes, 1 ♂, SPHTM, 1 ♂, 1 ♀, CSIRO), no collector's name; Burnett River (paratypes, 1 ♂, 1 ♀, BM), T. L. Bancroft. New South Wales: Moree, October, 1951 (1 ♂, CSIRO), A. L. Dyce.

**Cairnsimyia uniseta** sp. nov.

(Figs 5, 18)

♂ : Head yellowish-brown variably suffused with darker brown; occipital and postgenal regions very pale; a large blackish blotch on ocellars and a pair of smaller ones surrounding the fronto-orbitals. Thoracic pleura light yellowish with brownish-yellow longitudinal markings; mesonotum reddish-brown with a variable pattern of yellowish-grey markings; scutellum yellowish with a pair of brownish spots towards the base. Legs yellowish-brown; femora often darker brown, especially on apical part; tibiae with a broad black apical band, a slightly narrower band before the middle and a very narrow basal band. Abdomen yellowish-brown, the tergites often slightly darker laterally.

Wing whitish-hyaline with brown spots more numerous and crowded than in *C. cavifrons*, three or four spots in costal cell; veins brown, not much paler basally.

Head structurally similar to that of *C. cavifrons*; one fronto-orbital; postverticals present but very small. Arista with numerous minute dark hairs which are much shorter than its basal diameter.

Thorax with prescutellar acrostichals well developed; scutellum with apical bristles closer to each other than to lateral bristles; propleuron with fine erect hairs in centre, propleural represented by a rather weak black bristle; mesopleuron with

numerous, long, black hairs, sometimes one of those near posterior margin slightly thickened and bristle-like. Femora without thickened ventral bristles or spines. Wing with vein 2 diverging from vein 3 at apex.

Tergite 6 free, both spiracles of sixth and seventh pairs present below its lateral edges. Hypopygium rather small; surstyli spatulate, slightly curved, about three times as long as greatest width; parameres small and narrow, with up to about seven terminal claw-like spines; no additional appendages present. Cerci separate with rather short hairs.

Dimensions: total length 4.5–5.2 mm; length of thorax 2.2–2.7 mm; length of wing 5.0–5.7 mm.

Distribution: southeastern Queensland; eastern New South Wales; Victoria.

Material examined—New South Wales: Kurrajong, 30th October, 1958 (holotype ♂, AM) D. K. McAlpine; 20 miles northwest of Upper Colo, November, 1955 (paratypes, 3 ♂, CSIRO), T. G. Campbell. Victoria: Warburton, January, 1924 (1 ♂, SPHTM), F. E. Wilson. Queensland: Brisbane, November, 1913 (1 ♂, UQ), H. Hacker, August, 1931 (1 ♂, UQ), F. A. Perkins.

Habitat: holotype on trunk of *Angophora costata* in dry sclerophyll forest.

### **Cairnsimyia cavifrons** Malloch

(Fig. 19)

Malloch, 1931: 294–295, figs 1, 2.

McAlpine, 1958: fig. (as *Cairnsimyia* sp.).

Malloch's description is adequate for identification but the following points may be added:

Wing veins deep brown on entire distal part of wing and as far basad as primary forks of Rs (veins 2 and 3) and M (veins 4 and 5), basad of this level both veins and membrane conspicuously yellow.

Presutural bristles present but very small in all available specimens (absent in other species of the genus); mesopleuron with one to four outstanding setulae near posterior margin.

Surstyli about one and a half times as long as wide, dilated and slightly bilobed distally, the anterior lobe with fine hair-like setulae, the posterior one with short spine-like setulae on inner surface; lobes of hypandrium furnished with thickened setulae apically on inner surface; parameres appressed to inner basal surface of these lobes and thus not visible in lateral view, somewhat similar in form to those of *C. uniseta*. Aedeagus with a pair of unequally sclerotized longitudinal strips in basal part, the membranous distal part with a large irregular sclerite. Cerci very small and approximated but not completely fused.

♀: postabdomen normal, telescopic, with rather long, slender cerci.

Distribution: Queensland; northeastern New South Wales.

Material examined—Queensland: Cairns, 1907 (paratype ♂, AM), ex coll. B. Lichtwardt; Kuranda, September, 1910 (1 ♂, 1 ♀, BM, 1 ♂, AM), ex coll. E. A. Brunetti. New South Wales: Ulong, East Dorrigo district, no date (1 ♀, AM), W. Heron.

Other material (not seen by author): Cairns (holotype ♂, DEI), Kuranda (allotype and paratype, DEI), all ex Lichtwardt's collection.

It is suggested that both Lichtwardt's and Brunetti's material was probably collected by F. P. Dodd, who resided at Kuranda and sold insect specimens to collectors in many countries.

**Cairnsimyia crosskeyi** sp. nov.

(Figs 6, 20)

♂ ♀: Head and thorax yellowish, with reddish-brown markings. Head with a large jet-black spot between each antenna and eye, and a smaller brown-black spot below it; a brown-black patch enclosing the postverticals and ocelli; a brown-black spot on each side enclosing the inner and outer verticals and another surrounding the fronto-orbital; a large brown area covering most of anterior part of frons; face and cheeks with extensive tawny markings; antennae deep yellowish, third segment brownish dorsally; arista dark-brown, paler basally; palpi yellowish-brown; proboscis dark-brown. Scutellum dull yellowish dorsally with small tawny marks, brown-black ventrally and at bases of apical bristles. Legs yellow-brown, the femora suffused with darker brown; tibiae with two dark-brown transverse bands, one sub-basal and one apical; tarsi strongly browned distally. Wing yellowish along anterior margin, extensively spotted with brown as in fig. 6. Abdomen brownish, tergites 2-5 with whitish dusting medially, most extensive on tergite 5.

Height of head slightly less than twice the length at level of antennae; the following bristles well developed: vibrissae, one fronto-orbital, inner and outer vertical cruciate postverticals, ocellar, a series of somewhat finer cheek bristles behind vibrissa; occiput with fine hairs from which the postocular setulae are not clearly differentiated. Third antennal segment horizontally ovoid; arista filiform, apparently bare, but with sparse minute hairs visible at a magnification of  $\times 100$ .

Mesoscutum without prescutellar acrostichal and presutural bristles; scutellum subtriangular, the apical pair of bristles closely placed; propleuron with fine pale hairs near centre, and a short propleural bristle below; mesopleuron with fine dark setulae in front, which become longer and stronger on posterior margin; one rather weak sternopleural bristle. Femora without thickened ventral bristles or spines; tibiae without preapical dorsal bristles.

Surstylus almost three times as long as maximum width, narrowed basally, truncate and slightly sinuate apically, with numerous setulae on most of surface; lateral lobe of hypandrium with numerous short setulae along posterior margin, some stout ones extending almost to apex on inner surface. Aedeagus somewhat similar to that of *C. cavifrons*, sclerite in distal part large and complex. Cerci minute, pubescent, without setulae.

♀: postabdomen normal, retractile, with slender cerci.

Dimensions: total length, ♂ 4.3-6.0 mm, ♀ 4.5 mm; length of thorax, ♂ 2.5-3.3 mm, ♀ 3.0 mm; length of wing, ♂ 5.5-7.3 mm, ♀ 6.0-6.1 mm.

Distribution: Highlands of the Morobe District, New Guinea.

Material examined: Wau, 3,500-4,000 feet, 23rd May, 1965 (holotype ♂, BM, paratypes, 1 ♂, 1 ♀, BM, 1 ♂, AM, 1 ♀ CSIRO), R. W. Crosskey.

Habitat: specimens are labelled "At exudation on bark."

**Cairnsimyia inscripta** (Walker) new comb.

(Fig. 7)

*Platystoma inscripta* Walker, 1865: 120-121.

♂ ♀: Very similar to *C. crosskeyi*. Costal and marginal cells without yellowish coloration. Arista somewhat thickened, except at extreme apex, basal segment brown, remainder white, clothed with dense white pubescence. Scutellum slightly narrower than in *C. crosskeyi*, both available specimens with three scutellar bristles on left side and two on right. Surstylus appears (on dry whole specimen) to be very like that of *C. crosskeyi* in form, and with similar hairing.

Distribution: West New Guinea—Dorey.

Material examined—New Guinea (1 ♂, 1 ♀, BM), A. R. Wallace. Compared with holotype by J. C. Deeming.

Other material (not seen by author): New Guinea (holotype, BM), ex W. W. Saunders' collection, examined for the author by J. C. Deeming. Walker (1868) indicates that this species was discovered by A. R. Wallace in New Guinea. Hence it is apparent that all specimens of the species here recorded must have been collected at Dorey, the only locality in New Guinea where Wallace collected.

**Cairnsimyia aroana** sp. nov.

(Figs 8, 12, 21)

♂ ♀: Head yellowish with reddish-brown markings on frons, face, and cheeks; a dark-brown spot surrounding each posterior fronto-orbital bristle, one surrounding inner and outer vertexes, and one surrounding both postverticals and extending forwards to include the ocelli; a black spot between each antenna and eye; antennae deep yellowish, third segment slightly browned distally, arista black beyond base; palpi brownish-yellow; proboscis dark-brown. Thorax reddish-brown with extensive yellowish markings, the reddish-brown ground-colour partly obscured by pale blue-grey tomentum on pleura and sides of mesoscutum; scutellum whitish at apex. Legs brownish-yellow; tibiae with a broad brown apical transverse band and a rather obscure sub-basal one; tarsi brown, slightly paler basally. Wing with complex pattern of brown spots as in fig. 8. Abdominal tergites reddish-brown, paler at lateral margins; tergite 2 with large grey median patch; tergites 3-6 each with a pair of grey spots.

Height of head slightly more than (♂) or slightly less than (♀) twice the length at level of antennae; frons with a small pit or depression in front of anterior ocellus, a short transverse carina in front of this, below which the frons drops away vertically to ptilinal fissure; posterior fronto-orbital short and weak, anterior fronto-orbital very small or more frequently absent; outer verticals rather short and thick; inner verticals much shorter and thinner; postverticals moderately developed, incurved; ocellars usually indistinguishable; vibrissa no stronger than the anterior cheek bristles; postocular setulae short and fine above, thickened and spine-like below. Antenna as described for *C. crosskeyi*. Prelabrum with median process in male, which is reduced to little more than a prominence in female.

Thorax with humeral bristle absent (present in all other species of genus); prescutellar acrostichal and presutural bristles also absent; dorsocentral rather weak; scutellum transverse at apex, the apical bristles moderately close together; propleuron with numerous long pale hairs near centre, the propleural bristle pale and hair-like; most setulae on mesopleuron pale, hair-like, those near posterior margin blackish but not notably enlarged; sternopleural bristle small and weak. Femora without ventral spines; tibiae without preapical dorsal bristles.

Surstylus broadly triangular, very narrow at base, with a slight tooth or prominence on posterior margin; hypandrium with a comb of strong incurved setulae posteriorly near base on each side, its lobes with a few very short setulae on their inner surfaces, which do not extend to apices; aedeagus well sclerotized in both basal and distal sections; cerci minute, setulose, fused.

Female postabdomen as described for *C. crosskeyi*.

Dimensions: total length, ♂ 5.3–6.3 mm, ♀ 4.8–4.9 mm; length of thorax, ♂ 3.4–4.0 mm, ♀ 3.2 mm; length of wing, ♂ 6.3–7.5 mm, ♀ 5.6–6.1 mm.

Distribution: Papua—lowlands of the Central District.

Material examined: Aroana Estate, Aroa River, 6th December, 1963 (holotype ♂, paratypes, 3 ♂, 2 ♀, AM, paratype ♂, BM), D. K. McAlpine.

Habitat: all specimens taken at exuding sap of damaged tree (apparently *Ficus* sp.) in forest remnant.

## REFERENCES

- Hendel, F., 1916. Beiträge zur Systematik der Acalyptraten Musciden (Dipt.). *Ent. Mitt. Berl.*, 5: 294-299.
- Hennig, W., 1958. Die Familien der Diptera Schizophora und ihre phylogenetischen Verwandtschaftsbeziehungen. *Beitr. Ent.*, 8: 505-688.
- McAlpine, D.K., 1958. A family of flies new to Australia (Diptera, Rhinotoridae). *Proc. R. Zool. Soc. N.S.W.*, 1956-57: 64-65.
- Malloch, J. R., 1931. Notes on Australian Diptera. XXIX. *Proc. Linn. Soc. N.S.W.*, 56: 292-298.
- Steyskal, G. C., 1957. The Postabdomen of male acalyptrate Diptera. *Ann. Ent. Soc. Amer.*, 50: 66-73.
- Walker, F., 1853. *Insecta Saundersiana*. London. Diptera, 4: 253-414.
- 1865. Descriptions of new species of the dipterous insects of New Guinea. *J. Linn. Soc. London, Zool.*, 8: 102-130.
- 1868. Synopsis of the Diptera of the Eastern Archipelago discovered by Mr Wallace, and noticed in the "Journal of the Linnean Society." *J. Linn. Soc. London, Zool.*, 9: 1-30.
- Wheeler, M. R., 1954. *Rhinotora diversa* Giglio-Tos from the Southwestern United States (Diptera: Rhinotoridae). *Wasmann J. Biol.*, 12: 35-39.
- Williston, S. W., 1896. *Manual of the families and genera of North American Diptera*. 2nd ed. New Haven. liv and 167 pp.

## EXPLANATION OF FIGURES

1. *Cairnsimyia robusta*, wing, Kurrajong, New South Wales.
2. *C. sydneyensis*, wing of holotype.
3. *C. excavata*, wing of holotype.
4. *C. verticalis*, wing of holotype.
5. *C. uniseta*, wing of holotype.
6. *C. crosskeyi*, wing of holotype.
7. *C. inscripta*, wing.
8. *C. aroana*, wing of holotype.
9. *Neorhinotora mutica*, diagram of protandrium.
10. *Rhinotora pluricellata*, diagram of protandrium.
11. *Cairnsimyia robusta*, diagram of protandrium.
12. *C. aroana*, head of holotype.
13. *C. sydneyensis*, head of holotype.
14. *C. robusta*, Hornsby, New South Wales. A, epandrium. B, hypandrium (aedeagus not shown). C, inner aspect of right posterior paramere.
15. *C. excavata*, paratype. A, epandrium, B, hypandrium.
16. *C. sydneyensis*, paratype, Sydney, New South Wales. A, epandrium. B, hypandrium.
17. *C. verticalis*, genital segment of paratype, Eidsvold, Queensland.
18. *C. uniseta*, genital segment of paratype, Brisbane, Queensland.
19. *C. cavifrons*, Kuranda, Queensland. A, epandrium. B, left surstylus, posterolateral aspect (i.e., viewed at right angles to plane of surface). C, ejaculatory apodeme. D, hypandrium. E, right paramere, inner aspect.
20. *C. crosskeyi*, paratype. A, epandrium. B, hypandrium (aedeagus not shown).
21. *C. aroana*, paratype. A, epandrium. B, hypandrium.
22. *C. robusta*, last instar larva.
23. Cephalopharyngeal skeleton of same.
24. Facial region of same.
25. Left anterior spiracle of same.
26. Left posterior spiracle of same.

Note.—Unless otherwise stated, figures of genitalia are from the left lateral aspect. Setulae on tergite 9 have been omitted from some figures. a, aedeagus. ap, anterior paramere. b, ventral sclerotized band. c, cercus. pp, posterior paramere. s6-s9, sternites 6-9. sp, spiracle. ss, surstylus. t6-t9, tergites 6-9.



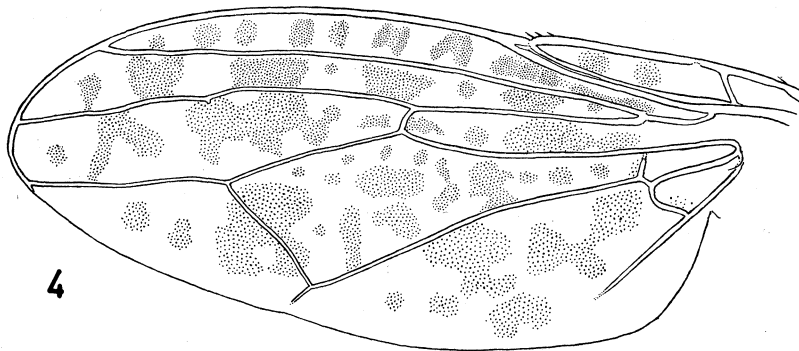
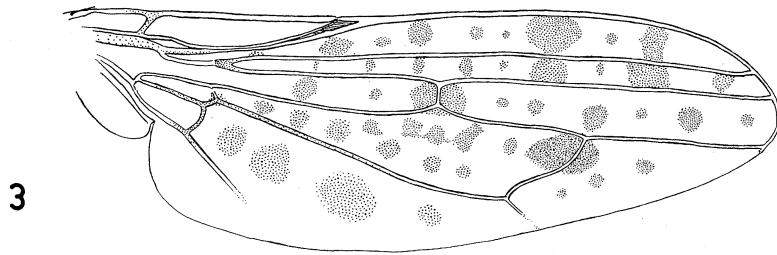
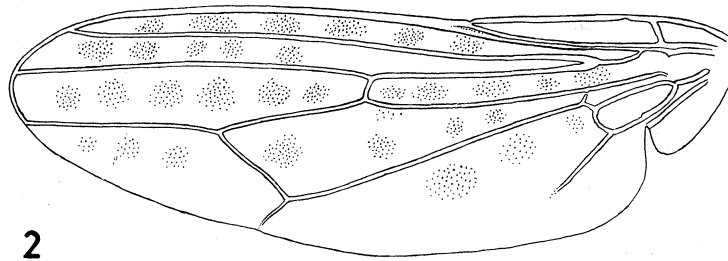
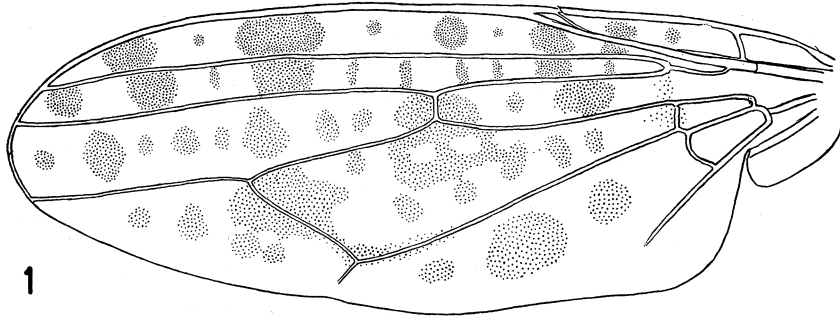

Figs 1-4

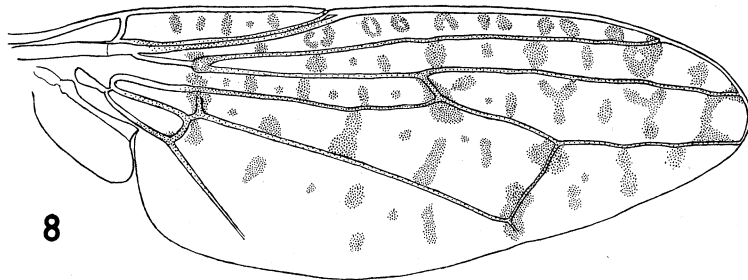
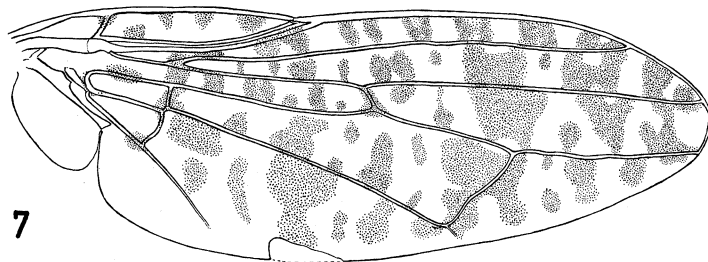
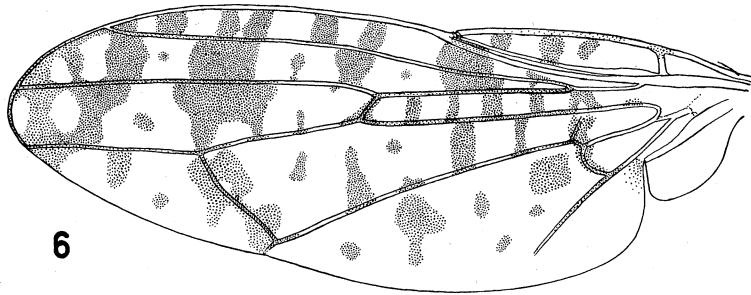
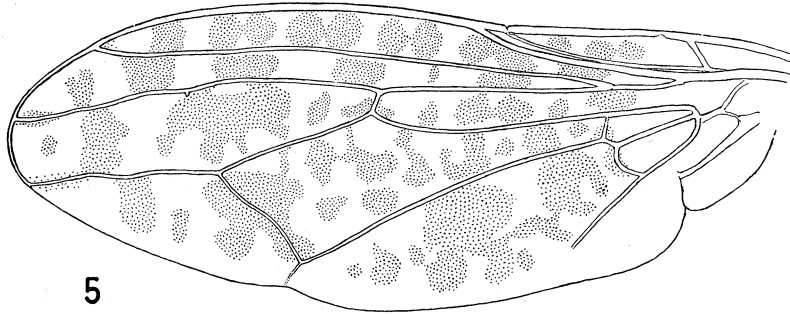

Figs 5-8

9

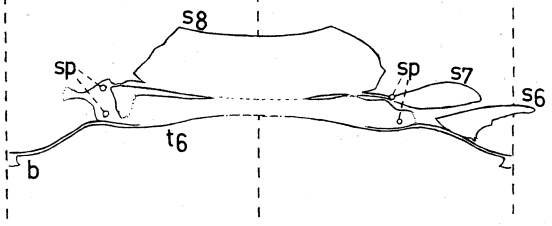

12

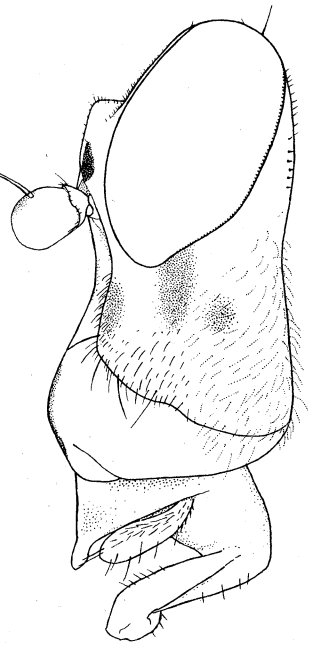

10

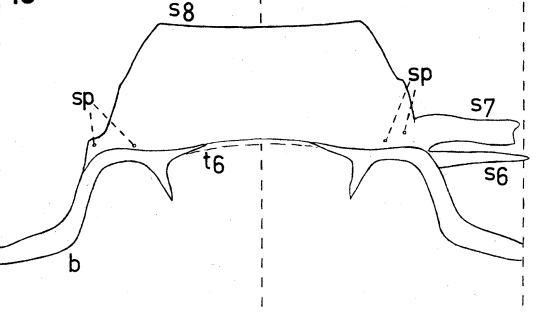

13

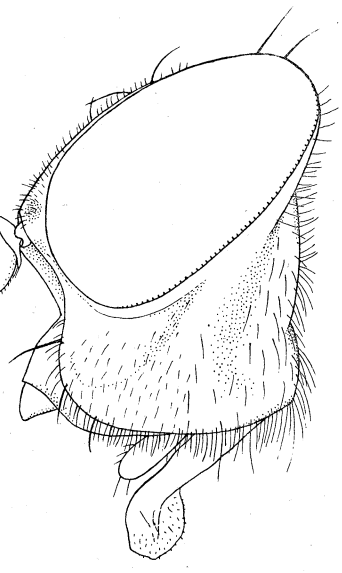

11

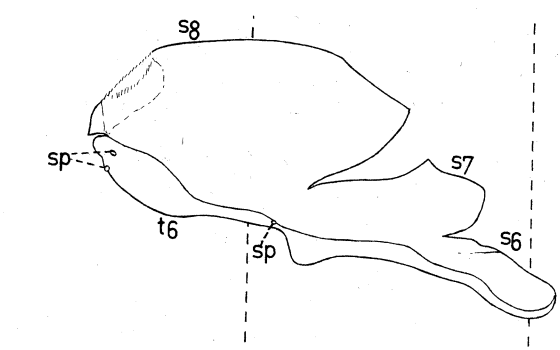

Figs 9-13

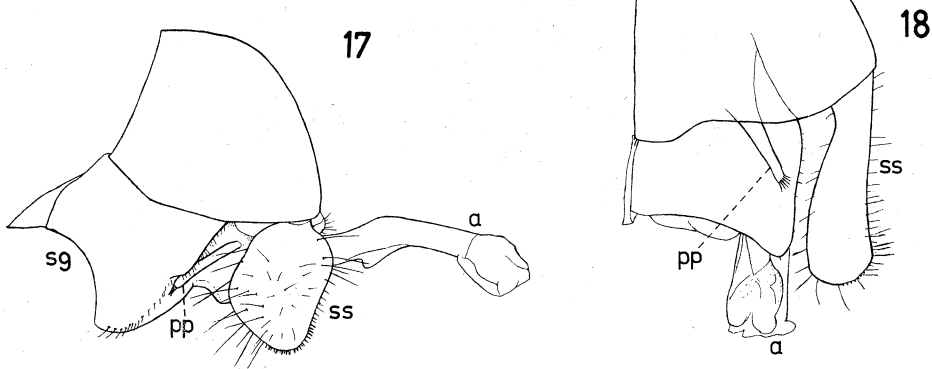
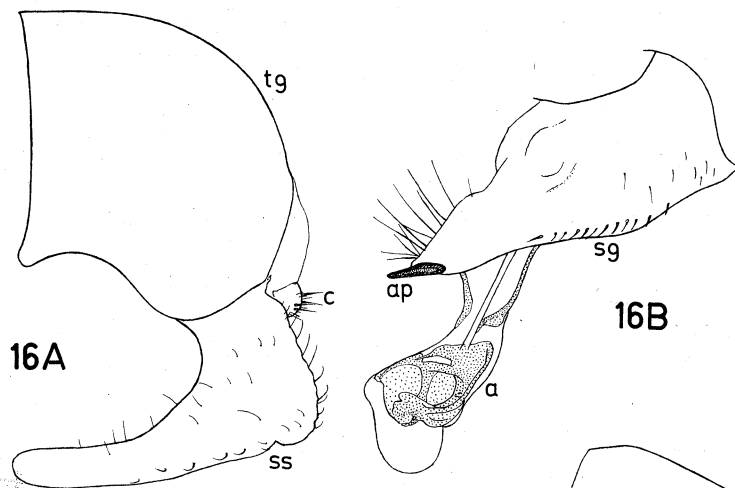
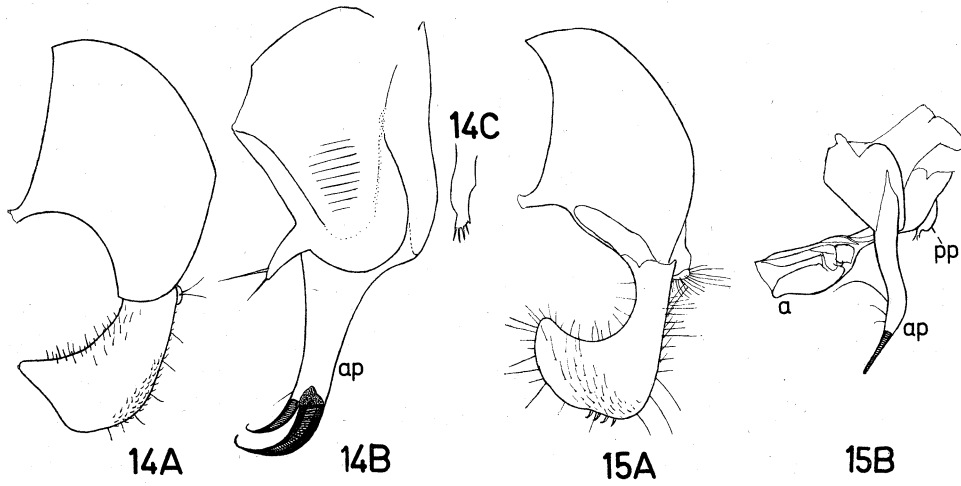

Figs 14-18.

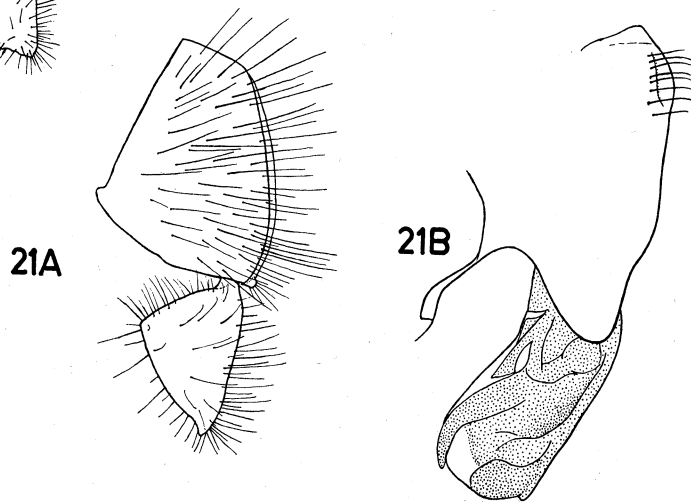
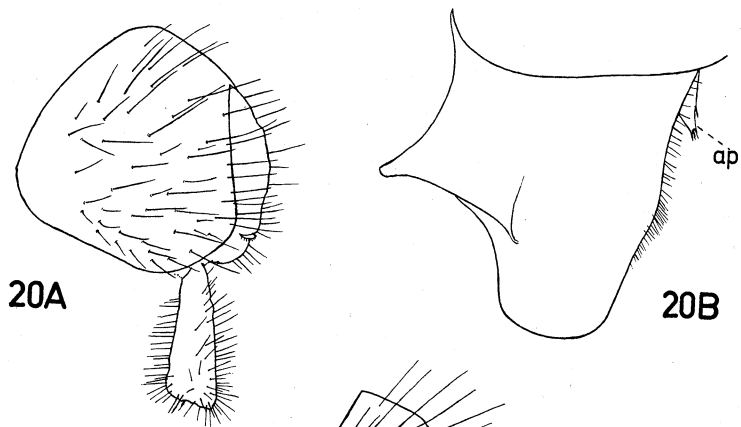
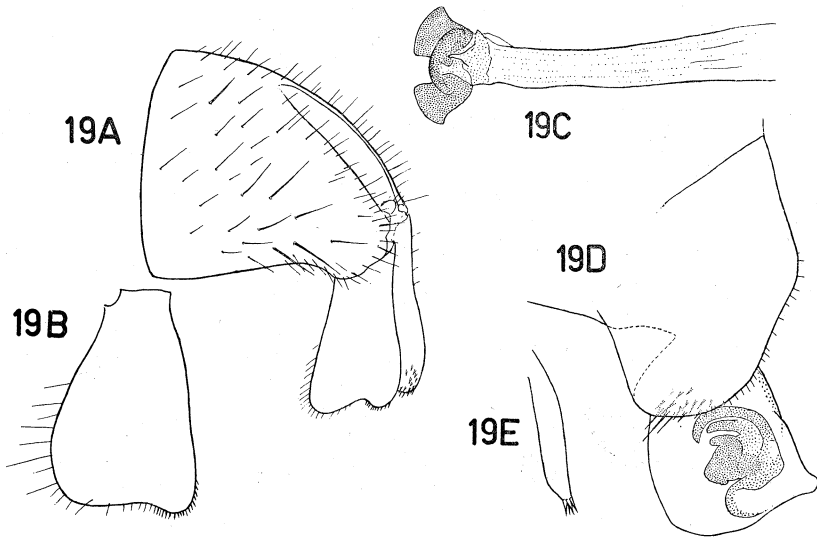

Figs 19-21

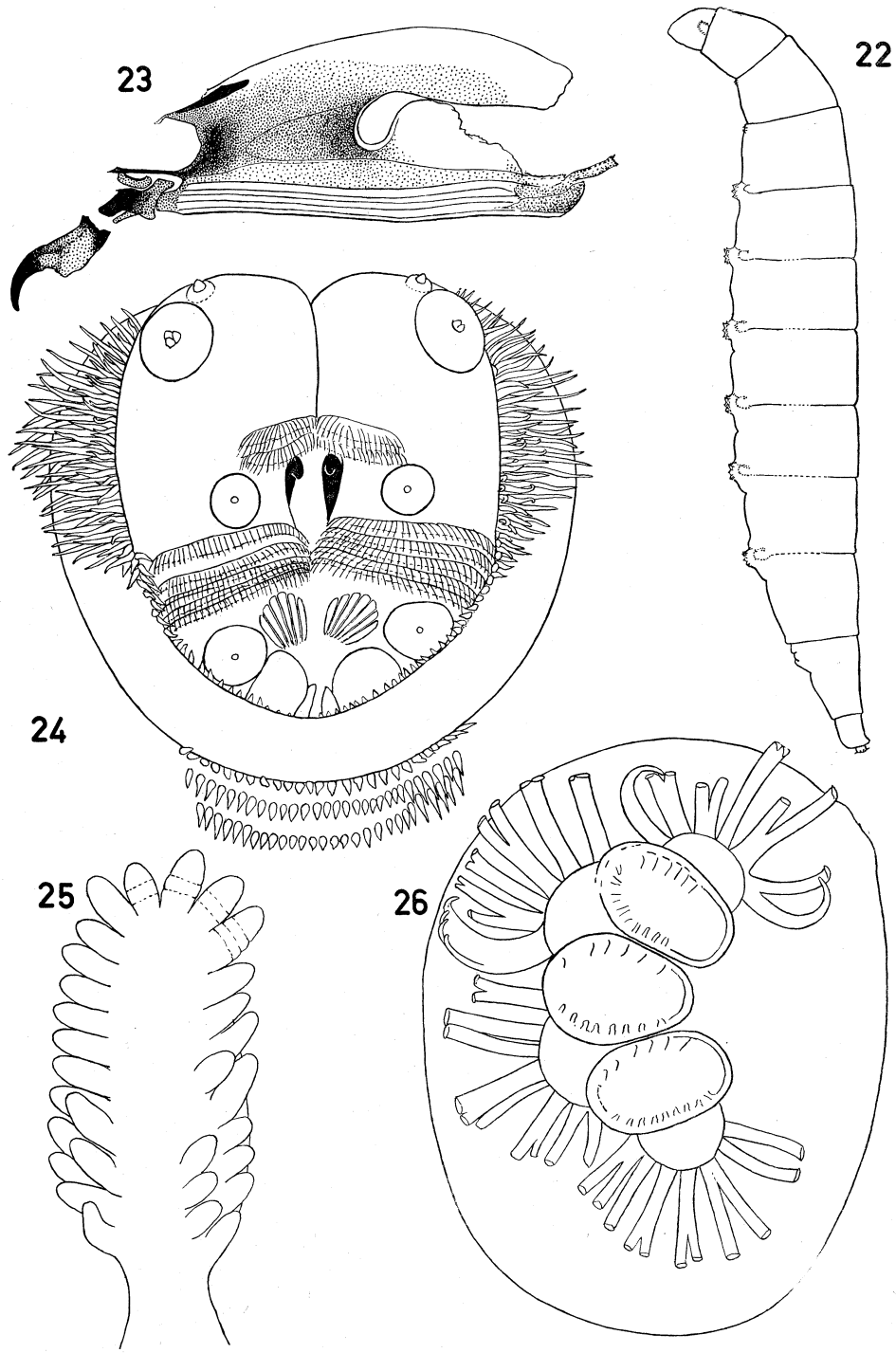

Figs 22-26