

# AUSTRALIAN MUSEUM SCIENTIFIC PUBLICATIONS

Hodge-Smith, T., 1930. Mineralogical notes. No. IV. *Records of the Australian Museum* 17(9): 408–414. [27 June 1930].

doi:10.3853/j.0067-1975.17.1930.774

ISSN 0067-1975

Published by the Australian Museum, Sydney

nature culture **discover**

Australian Museum science is freely accessible online at  
<http://publications.australianmuseum.net.au>  
6 College Street, Sydney NSW 2010, Australia



# MINERALOGICAL NOTES.

No. IV.\*

By

T. HODGE-SMITH,

Mineralogist and Petrologist, The Australian Museum.

BARITE.

Northmead, near Parramatta, New South Wales.

(Figures 1-3.)

The first record of barite occurring in the Hawkesbury sandstone in the vicinity of Sydney was made by Mr. H. G. Smith<sup>1</sup> in 1891, the locality given being Cook's River, five miles west of Sydney. Since then it has been recorded from Five Dock, Pyrmont, Pennant Hills,<sup>2</sup> Dundas,<sup>3</sup> St. Peters, Macdonaldtown, and Thirlmere.<sup>4</sup>

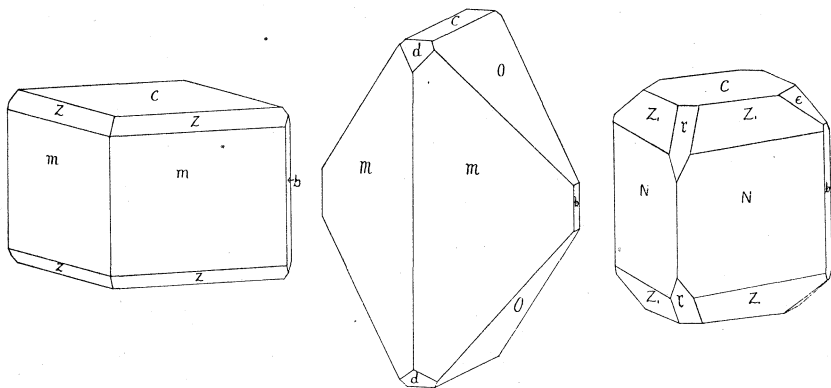

Figures 1-3.

Barite from Northmead, near Parramatta, New South Wales.

Forms.—c(001), b(010), m(110), N(230), o(011), ε(035),  
d(102), τ(405), z(111), and the new form Z<sub>1</sub>(465).

In all these occurrences, with the exception of Dundas, the barite is recorded as being found in the Triassic sedimentary rocks of which the Hawkesbury Sandstone is a part. At Dundas it was found associated with calcite, aragonite, and amethystine quartz in

\* For No. III, see "Records of the Australian Museum," Vol. xv, No. 5, 1927, p. 313.

<sup>1</sup> Smith.—Proc. Linn. Soc. N. S. Wales, (2), vi, 1892, pp. 131-132.

<sup>2</sup> David.—Journ. Roy. Soc. N. S. Wales, xxvii, 1894, p. 407.

<sup>3</sup> Benson.—*Ibid.*, xliv, 1910, p. 501.

<sup>4</sup> Anderson.—Rec. Austr. Mus., vi, 1905, p. 89.

small vughs in the basalt of a volcanic neck which penetrates the Triassic Series. In every case the barite is found well crystallized. In all the specimens that I have examined, the mineral occurs coating the sandstone or shale, having been deposited apparently along crevices and joint planes in the rock. The crystals described in this paper were found in small egg-shaped cavities in a mass of solid sandstone at Pye's Quarry, Northmead, near Parramatta. The cavities are filled with a moist greyish mud, which on drying takes on a pinkish hue, and the crystals are always found embedded in the mud but never attached to the sides of the vughs. Their distribution appears to be somewhat restricted; they are limited in a vertical direction to approximately two metres, though horizontally their extent is considerably greater. They are either oval or spherical in shape, rarely exceeding ten centimetres in diameter, with the longer axis invariably lying in the horizontal plane.

The crystals are colourless and transparent, though they sometimes show a zonal structure, and often have inclusions of the muddy material. They are different in habit from any of the crystals previously described from this formation, and appear to form two definite types. About a hundred crystals were examined and only one was found which did not conform to either of the types. It is prismatic in habit. The prism faces belong to the form N (230), and are well developed, while the brachy-pinacoid is represented by a long narrow face. The crystal is terminated by the basal plane modified by the brachydome  $\tau$  (405), the rare macrodome  $\epsilon$  (035), and a new form  $Z_1$  (456). This new form is represented by a full complement of faces, which give fairly good signals. The measured  $\phi$  and  $\rho$  angles are  $39^\circ 7'$  and  $63^\circ 45'$ , and the calculated angles are  $39^\circ 16'$  and  $63^\circ 51'$ .

TABLE I.

Form.	Measured.		Calculated.		Error.	
	$\phi$	$\rho$	$\phi$	$\rho$	$\phi$	$\rho$
c(001) .. ..	—	0 00	—	0 00	0	0
b(010) .. ..	0 00	90 00	0 00	90 00	0	0
m(110) .. ..	50 52	90 00	50 49	90 00	3	0
N(230) .. ..	39 04	90 00	39 16	90 00	12	0
o(011) .. ..	0 00	52 46	0 00	52 43	0	3
$\epsilon$ (035) .. ..	0 07	37 54	0 00	38 15	7	21
d(102) .. ..	89 48	38 48	90 00	38 51	2	3
$\tau$ (405) .. ..	90 00	52 24	90 00	52 13	0	11
z(111) .. ..	50 36	64 13	50 49	64 18	13	5
$Z_1$ (465) .. ..	39 07	63 45	39 16	63 51	9	6

Type 1.—The largest crystal found of this type measures 6 mm. by 7 mm. by 4 mm. along the three crystallographic axes; more generally they are about half this size. The habit is very simple and the forms  $m(110)$  and  $c(001)$  are invariably present and well developed and are often modified by narrow faces of the forms  $b(010)$  and  $z(111)$ . This type of crystal is by far the most common of those collected here.

Type 2.—Only a comparatively few crystals of this type were procured. The main difference from the crystals of Type 1 is the development of the brachydome  $o(011)$ . Occasionally also the macrodome  $d(102)$  is developed to a lesser degree.

Professor Sir T. W. Edgeworth David<sup>5</sup> has suggested that the origin of the barite in these Triassic and other sedimentary rocks in New South Wales is due to the decomposition of detrital barytic feldspars. In this case it would seem that the barite was due to the precipitation of barium sulphate by the action of sulphate of iron and sulphuric acid set free by the decomposition of pyrite on percolating ground waters containing a soluble barium salt. No pyrite has been found in the mud-filled cavities, but pyritic nodules of similar shape and size are known to exist in these rocks.

#### STURTITE: A NEW MINERAL.

Broken Hill, New South Wales.

This new mineral was first brought under my notice by Mr. E. M. Holder, and later some very fine specimens were secured from Mr. M. Mawby. It is found in the Zinc Corporation Mine, Broken Hill, New South Wales.

It is amorphous, compact, with a sub-conchoidal to uneven fracture, and is very brittle and friable, breaking up in the fingers with ease. The hardness is slightly over 3, and the streak is yellowish-brown. The lustre is vitreous inclining to greasy. The colour is jet black. The specific gravity is 2.054.

A thin section under the microscope is transparent, pale brown in colour, and isotropic. There is no sign of crystallization.

Before the blowpipe the mineral fuses with difficulty to a black magnetic mass. In the closed tube it gives off abundant water. It is decomposed in acid with the separation of granular silica.

About 4.86 grammes were carefully picked free from impurities and used for analysis. Minute grains of quartz occur intimately associated with the mineral, but these were fairly success-

---

<sup>5</sup> Anderson.—*Loc. cit.*

fully eliminated as will be seen by the analysis. The results of the analysis, which was very kindly carried out for me by Mr. H. P. White, are shown in Table II.

TABLE II.—Analysis of Sturtite from Broken Hill.

	Weight, per cent.	Molecular weight.	Molecular ratio.	Theoretical weight, per cent.
SiO <sub>2</sub> free* .. ..	0.79			
SiO <sub>2</sub> combined .. ..	32.35	0.539	7.92	32.43
Fe <sub>2</sub> O <sub>3</sub> .. .. .	10.22	} 0.068	1.00	10.81
Al <sub>2</sub> O <sub>3</sub> .. .. .	0.44			
MnO .. .. .	25.18	} 0.405	5.96	28.79
CaO .. .. .	2.19			
MgO .. .. .	0.65			
H <sub>2</sub> O .. .. .	28.16	1.565	23.01	27.97
	99.98			100.00

\* Including a trace of a silicate mineral.

It is important to note that partial analyses by Mr. Mawby and myself substantially agree with the above result, indicating that the mineral is homogeneous in composition.

From the molecular ratios deduced from the analysis it will be seen that the formula may be written thus:

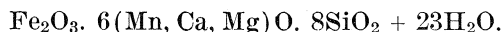

The absence of ferrous iron, and also that of the higher oxides of manganese has been proved, so that, in view of the fact that there is a deficiency of silica, it may be reasonably assumed that the iron is combined with silica and water thus:

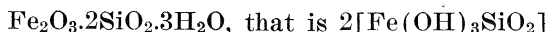

The formula would then be written:

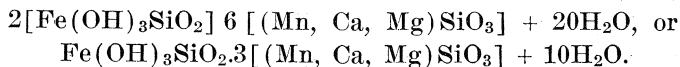

However, the iron molecule is not considered to exist as such, and should therefore be combined with the manganese molecule, which reduces the formula to

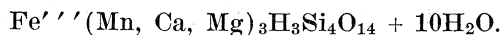

The general formula may be written:

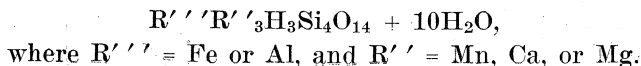

It is obvious that this substance is a salt of the hypothetical orthodisilicic acid ( $H_6Si_2O_7$ ) with water in combination. In order to ascertain whether the distribution of water as indicated in the above formula was justified, Mr. White carried out experiments to determine at what temperature the water was driven off. His results are shown in Table III. While the results obtained do not necessarily prove that the distribution of the water is correct, it at least lends very strong support to this assumption, as it will be seen in the last column of the table that 3.38 is the molecular ratio of water driven off at temperatures above  $140^\circ C$ .

TABLE III.—Dehydration of Sturtite.

Temperature $^\circ C$ .	Per cent. weight of water driven off.	Molecular Weight.	Molecular Ratio.
90-105 .. ..	23.01	1.278	18.80
105-140 .. ..	1.02	0.057	0.83
Above 140 ..	4.13	0.230	3.38
	28.16	1.565	23.01

The method used in the above experiments was to weigh the amount of water absorbed by calcium chloride in a U-tube. The powder after the experiment was found to have turned black and increased in weight. On the addition of hydrochloric acid and gently warming, a considerable quantity of chlorine was given off, whereas no chlorine is evolved by the action of acid on the original mineral. Thus on heating the mineral is broken up, and the manganous oxide set free is capable of taking up oxygen to form a higher oxide.

The Australian Museum collection contains about twenty specimens of this mineral, and an examination of these shows that the associated minerals are quartz, amethystine quartz, spessartite, rhodocrosite, calcite, galena, and sphalerite. In a letter from Mr. Mawby, he informs me that rhodonite and manganhedenbergite are also in close association with this mineral. The galena occurs entirely enclosed by sturtite as irregular masses with a perfect cubic cleavage. I have not had the opportunity of visiting the occurrence so that I am unable to give any information on this point.

The name sturtite is proposed for this mineral in honour of the famous explorer Captain Charles Sturt who, as the first white man, visited Broken Hill on the 22nd October, 1844, and, according to Dr. John Harris Browne, secured the first specimens of the great lode itself.

## WOLFRAMITE.

Mount Bell District, Tasmania.

(Figure 4.)

Among the Museum collection of wolframite is a large crystal from the Shepherd and Murphy mine, twelve miles south-west from Wilmot, in the Mount Bell district, Tasmania. The specimen measures 59 mm. by 35 mm. by 35 mm., and is partly enclosed by

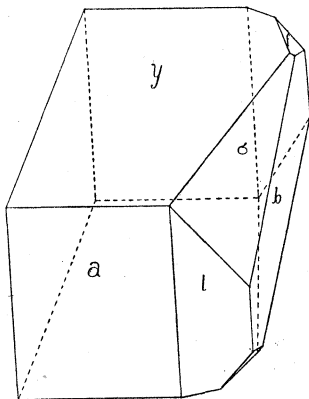

Figure 4.

Wolframite from the Shepherd and Murphy Mine,  
Mount Bell district, Tasmania.

Forms.— $a(100)$ ,  $b(010)$ ,  $y(102)$ ,  $f(011)$ , and  $\sigma(121)$ .

fluorite of pale green colour. According to Mr. W. H. Twelvetrees,<sup>6</sup> other minerals associated with the wolframite of this mine are quartz, calcite, wollastonite, occasionally spodumene, a hydrated mica, and a little topaz.

The angular measurements were made with a contact goniometer, and were sufficiently accurate to determine the forms present, but not good enough to distinguish between the positive and negative forms. However, the forms are either all positive or all negative, and on the measurements of the angle between  $a$  and  $y$ , it appears to be a fair assumption that they are all positive. The forms present are  $a(100)$ ,  $b(010)$ ,  $y(102)$ ,  $f(011)$  and  $\sigma(121)$ . Only one face of the clino-pinacoid was visible, the other was covered partly by fluorite and partly represented by cleavage planes.

<sup>6</sup>Tasmanian Secretary for Mines, Report for 1907, p. xi.

